

**RICCONI<sup>®</sup>**

LIGHTING CATALOGUE









### **10 years UK manufacture of lighting**

Over 50% of our products are made in the UK. At RICOMAN, we believe in the importance of investing in UK lighting manufacturing.

By enhancing our facilities, supply chain, and partnerships, we ensure the efficient production of high-quality lighting products, meeting the growing demands of our customers and ensuring their satisfaction.

### **Lighting design**

With a team of technical and creative lighting designers and project managers, we offer comprehensive services including CAD design, 3D renders, fully compliant lighting designs, and expert technical and design advice.

### **Environmental impact**

We are committed to sustainability and have introduced various initiatives to reduce our environmental impact. These include adopting an electric car fleet, eliminating plastics from packaging where possible, and recycling materials with a cardboard shredder to minimise landfill waste.

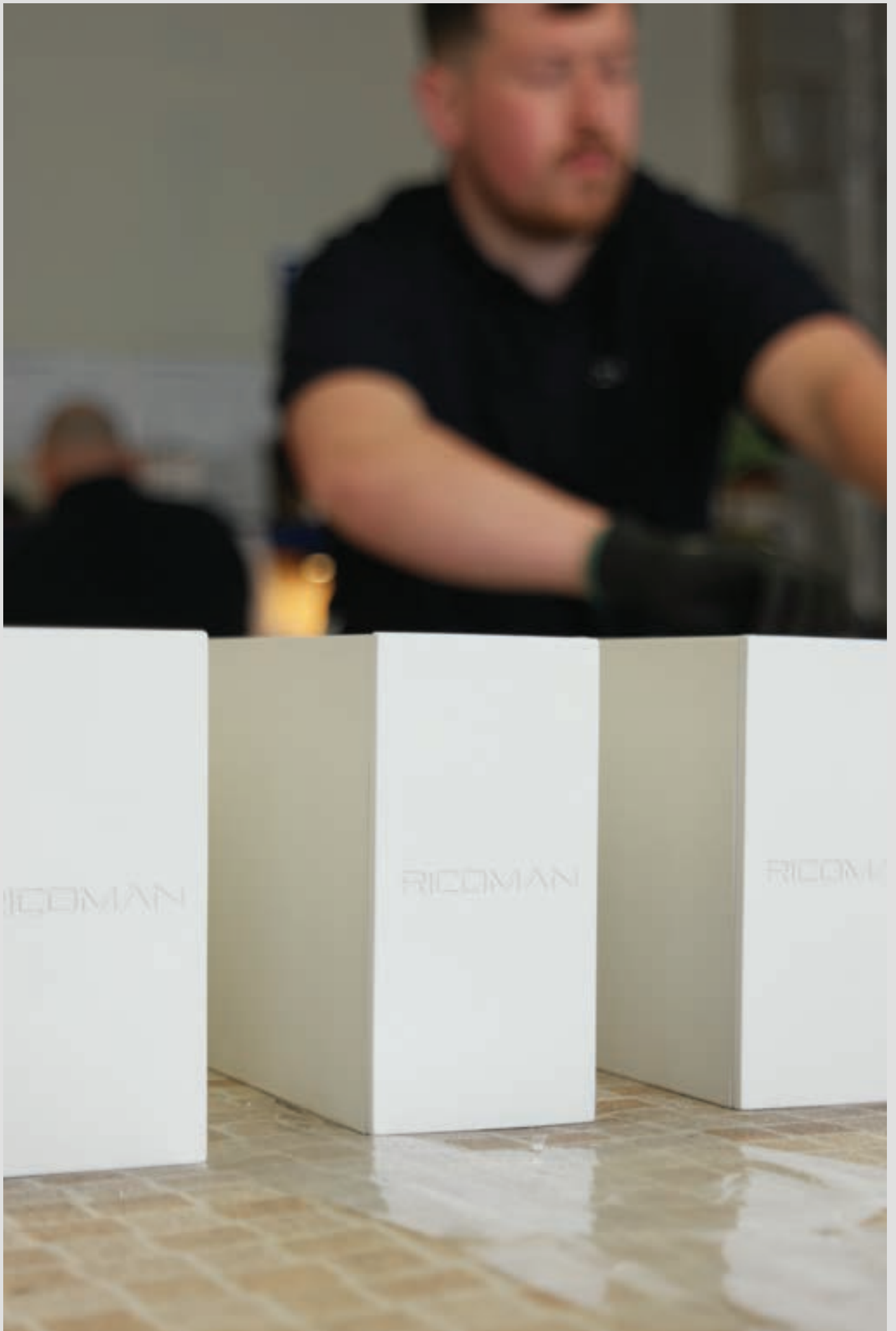



### **Product development**

Our product development team create high-performance lighting products that boast excellent performance and class leading technology. We can also make swift and efficient customisations in order to create products that are truly specification-compliant.



### **Casambi**

The Casambi lighting system offers seamless control over lighting, allowing wireless brightness adjustments, colour temperature and scenes, through a simple app or wall control. Casambi improves energy efficiency and makes creating the perfect ambience a simple task.

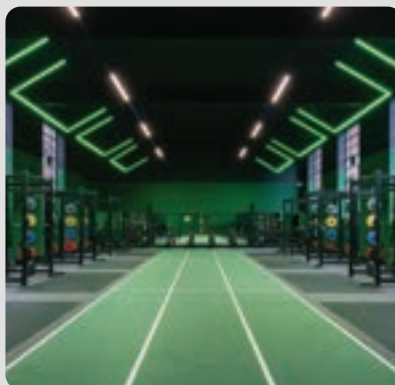

### **Integrated solutions**

From cable management systems, pre-wired luminaires or smart control systems, at RICOMAN we aim to add value to our clients offering integrated solutions by saving time for your installers. Talk to our team and get your luminaires pre-wired and ready delivered on-site.

## LINEAR LIGHTING

**Projects** p.12, **Estrella Pro** linear system p.26, **Flow** the curved linear system p.36, **Astrowave** the flexible 360° neon light system p. 44, **Neon Flex** p.52, **Aeroline** p.54, **Ricostrip** p. 56.

## PENDANT LIGHTING

**Projects** p.60 **Flow Rings** p.68, **Sounds Like Light** Acoustic lighting p.74, **Galaxia** p.92, **Nebula** p.95, **FloraLume** Biophilic lighting p.96, **Moon** p.100, **Pulsar** p.104.

## DOWNLIGHTS

**Projects** p.108 **Neptune** IP65 Low Glare p.116, **E-pro** architectural p.118, **Core** p.124, **R3** p.125, **Pinnacle** p.126, **Endor** Customisable p.128, **Sirius** Commercial p.134, **Ultra Slim** p.135, **Carina** p.136, **Centorio** p.137, **Protium** p.138, **Protium Max** p.139, **Modus** p.140 **Saturn** p.142 **Modus Max** p.143, **Pulsar Lite** spotlight p. 144.

#### Track Lighting

**Projects** p.150, **E-Pro track** p.160, **Zenith** p.161 **Pulsar Lite track** p.162, **Pulsar pendant track** p.163, **Egress track exit sign** p.164, **Draco track emergency** p.165, **Tracks & Accessories for 3 circuit** p.166, **Zodiac 48V track system** p.168.

#### RECESSED MODULAR LIGHTING

**Core Plus backlit panel light** p.186, **Core UGR Low UGR Backlit Panel** p.187, **Aquavance Ip66 rated panel** p.188, **Pure Panel 5x5 panel light** p.190, **Libra** p. 191, **CTC Panel** p. 192, **RGBw** p.193, **Sky Panels** p.194, **Panel Accessories** p.196.

#### AMENITY, EMERGENCY AND INDUSTRIAL LIGHTING

**Projects** p.200, **Outdoor** p.206, **Bulkheads** p. 214. **Industrial** p. 222, **Emergency** p. 230.







# **Xcite Gym, Exert HIT Studio in Scotland.**

RICOMAN supplied lighting to West Lothian Leisure Xcite, a unique training studio with modern TechnoGym equipment. This lighting project was designed by Bryan Gardner at Rexel Lighting Design in Edinburgh, with the electrical work executed by John Noble Electrical.

To enhance the bespoke training experience, West Lothian Leisure chose RICOMAN's **Estrella Pro in RGBW for its flexibility.**

Configured in X shapes and continuous lines, it illuminated different sections. **Casambi technology** allowed individual or group control of lighting via an iPad app, providing limitless scene options.

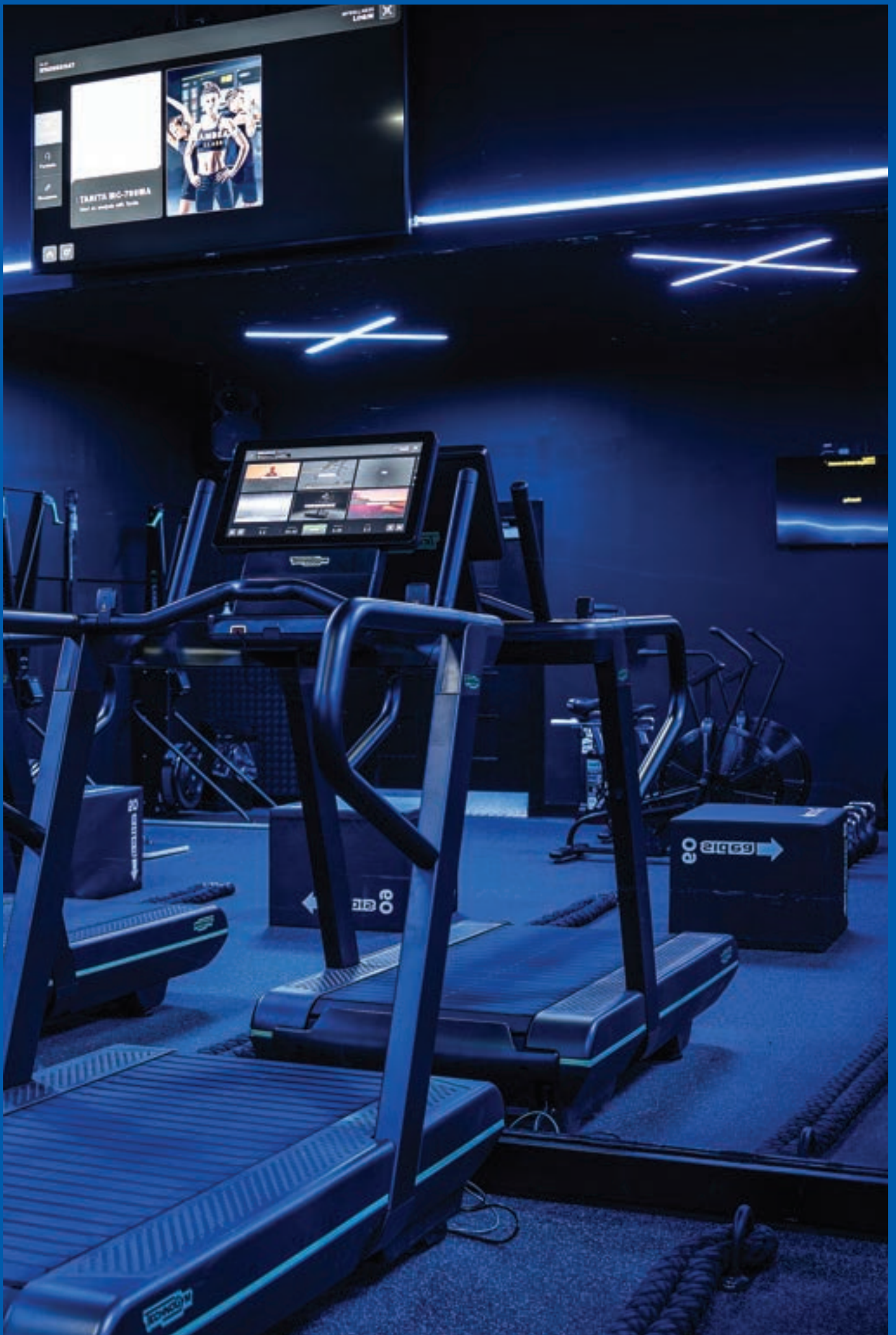







# Flour Patisserie, in Jersey.



**Flour Patisserie** in Jersey  
Client: LED Lighting Jersey / Photos: LED Lighting Jersey





**Flow our curved feature lighting system** was designed by RICOMAN and used in a new and contemporary cake & coffee shop in Jersey, Flour the Patisserie.





# Linear lighting

# Estrella Pro linear lighting system.



R3-----

# Estrella Pro linear system



CRI	>90 Ra
Operating Hours	50,000
SDCM	≤4
L70 B50	100,000 hours
IP Rating	IP20



### Mounting options



#### R34

Surface mounted or suspended

Width	50
Height	100

#### R35

Recessed

Width	64
Height	47

### Lengths

**05**  
532mm

**10**  
1064mm

**16**  
1596mm

**21**  
2128mm

**01**  
L Shape  
(not available for wallwash version)

**02**  
T Shape  
(not available for recessed and wallwash version)

**03**  
+ Shape  
(not available for recessed and wallwash version)

### Customisable lengths and shapes

### Optics



**01**  
Opal

Efficacy	120Lm/W
Beam Angle	100°

**02**  
Square aperture

Efficacy	125Lm/W
Beam Angle	90°

**03**  
Round aperture

Efficacy	125Lm/W
Beam Angle	50°

**04**  
Wallwash aperture

Efficacy	116Lm/W
Beam Angle	60°

**05**  
Dark louvre

Efficacy	75Lm/W
Beam Angle	70°



**06**  
Mirror louvre

Efficacy	96Lm/W
Beam Angle	70°

**07**  
White louvre

Efficacy	104Lm/W
Beam Angle	70°

**09**  
UGR

Efficacy	100Lm/W
Beam Angle	100°

Seamless continuous lines of light and shapes, available as a surface/suspended version with an optional indirect light output, also available as a recessed linear. Estrella pro boasts a range of eight optical solutions and the option of an integrated tiltable spotlight.

**Colour Finish**



**/WT**  
Matte white RAL9016



**/BK**  
Matte black RAL9005



**/RALXXXX**  
Special colour, replace XXXX with RAL

**Kelvin**

**/3K**  
3000K

**/4K**  
4000K

**/5K**  
5000K

**/TW**  
Tunable white

**/RGBW**  
RGBW

**Integrations**



**/SPT**  
Integrated with Pulsar Spotlight

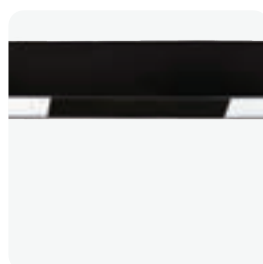

**/BP**  
Blanking Plate



**/UP**  
Direct / Indirect light output  
(not available on recessed)

**Output**

**/7W**  
532mm

**/14W**  
532mm  
1064mm

**/26W**  
532mm

**/28W**  
1064mm  
2128mm

**/52W**  
1064mm

**/21W**  
1596mm

**/42W**  
1596mm

**/78W**  
1596mm

**/56W**  
2128mm



**XO Fitness Gym** in Ilkley  
Lighting design: RICOMAN Lighting. Electrical contractor: TAC Electrical





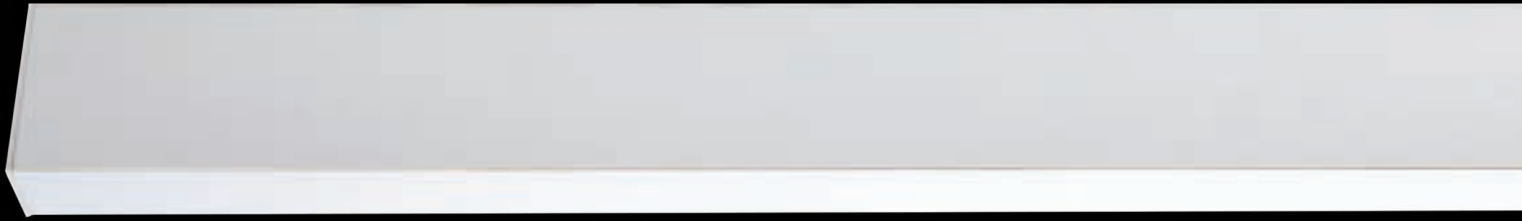

## Options

### /E

3 hour emergency

### /EMPRO

3 hour DALI addressable emergency

### /E-Z10

Z10 Integral emergency with remote control testing

### /PRI

PIR sensor

### /CC

CASAMBI controls

### /DD

DALI dimming

## Accessories

<b>R33-11</b>	Recessed Clips
<b>R33-04</b>	Connection Pack (Not Needed On Recessed)
<b>R33-06</b>	Surface Mounting Clips
<b>R33-07</b>	3m Suspension Kit
<b>R33-08</b>	T Bar Grid Ceiling Kit
<b>R33-09</b>	Track Mounting Kit
<b>R33-10</b>	Side Wall Mounting Kit
<b>R33-12</b>	Solid Rod Mounting Kit
<b>R10-Z10</b>	Z10 Emergency Remote Control
<b>R33-37</b>	Estrella Pro 3m Suspension Kit 2 Point Pack
<b>R33-14</b>	Estrella Pro 2 In 1 Connection Pack And Suspension



**Code Example** R341101/WT/3K/UP/28W: Estrella Pro Opal 1064mm 28W white body in 3000K with direct+indirect light.

**Flow curved**  
linear system.



THERE'S ALWAYS  
ROOM FOR DESSE



Flow system is comprised of straight and arc shaped modules that can be combined in creative ways to create unique lighting environments.

R36-----

# Flow curved linear system



Efficacy	57 Lm/W
----------	---------

CRI	>90 Ra
-----	--------

Beam Angle	120°
------------	------

Operating Hours	50,000
-----------------	--------

SDCM	≤3
------	----

IP Rating	IP20
-----------	------



Imagine Flow flowing freely, creating independent or crossing rings, waves, spirals, interconnecting curves. The direction of the light moving from downwards to inwards and outwards. Straight lines ending up in curves, transforming from 2D to 3D lighting, creating unlimited possibilities.

#### Light direction



1  
Downwards lighting



2  
Outwards lighting



3  
Inwards Lighting

#### Shape



1  
Straight profile



2  
45 degree arc profile



3  
90 degree arc profile



4  
Twist left 90 degrees profile

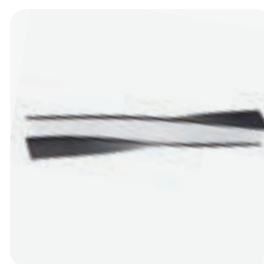

5  
Twist right 90 degrees profile



6  
Twist 180 degrees profile

# Flow curved linear system

## Models

### 250

2500mm length for straight profile.

Length	<b>2500</b>
Lumens	<b>462Lm</b>
Wattage	<b>45W</b>

### 30

320mm diameter circle for arc profiles

Length	<b>250</b>
Lumens	<b>295Lm</b>
Wattage	<b>5W</b>

### 80

800mm diameter for arc profiles

Length	<b>310 / 630</b>
Lumens	<b>355Lm / 612Lm</b>
Wattage	<b>6W / 11W</b>

### 150

1500mm diameter circle for arc profiles

Length	<b>590 / 1180</b>
Lumens	<b>571Lm / 1358Lm</b>
Wattage	<b>11W / 22W</b>

### 300

3000mm diameter circle for arc profiles

Length	<b>1180</b>
Lumens	<b>1243Lm</b>
Wattage	<b>20W</b>

### 40

400mm length circle for twist profile.

Length	<b>400</b>
Lumens	<b>462Lm</b>
Wattage	<b>8W</b>

### 50

500mm length circle for twist profile.

Length	<b>500</b>
Lumens	<b>538Lm</b>
Wattage	<b>10W</b>

## Colour Finish



### /WT

Matte white RAL9003



### /BK

Matte black RAL9005



### /SV

Matte silver RAL9006

## Kelvin

### /3K

3000K

### /4K

4000K

## Code Example

R3633150/WT/3K/: Flow 90° arc, 1500mm Inwards lighting in white body in 3000K.

## Accessories

<b>R36-01</b>	Flow 20m roll of diffuser
<b>R36-02</b>	Flow End caps (/BK, /WT, /SV)
<b>R36-03</b>	Flow 2m Suspension kit
<b>R36-04</b>	Flow 2m 2 in 1 flex and suspension kit
<b>R36-06</b>	Flow inward/outwards lighting mounting buckle
<b>R36-07</b>	Flow downwards lighting mounting buckle
<b>R36-09</b>	Flow connection pack



**LNT Offices** in Leeds  
Lighting design: RICOMAN Lighting.

## Flow curved linear system

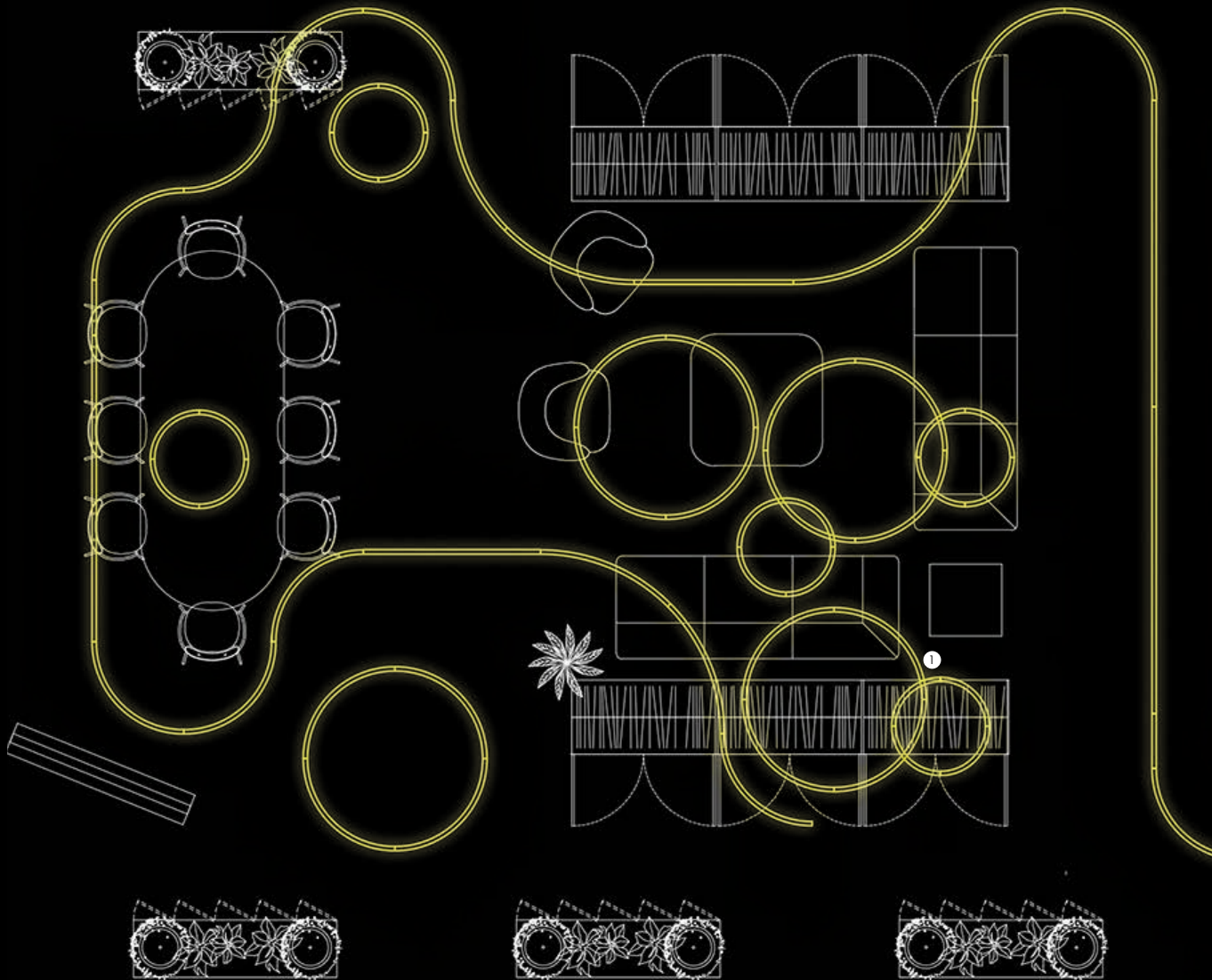

We offer tailored lighting design solutions, along with detailed renders, so you can visualise how your project looks like. Whether it's for a commercial or residential space, our team will guide you through the process to ensure the perfect lighting solutions.

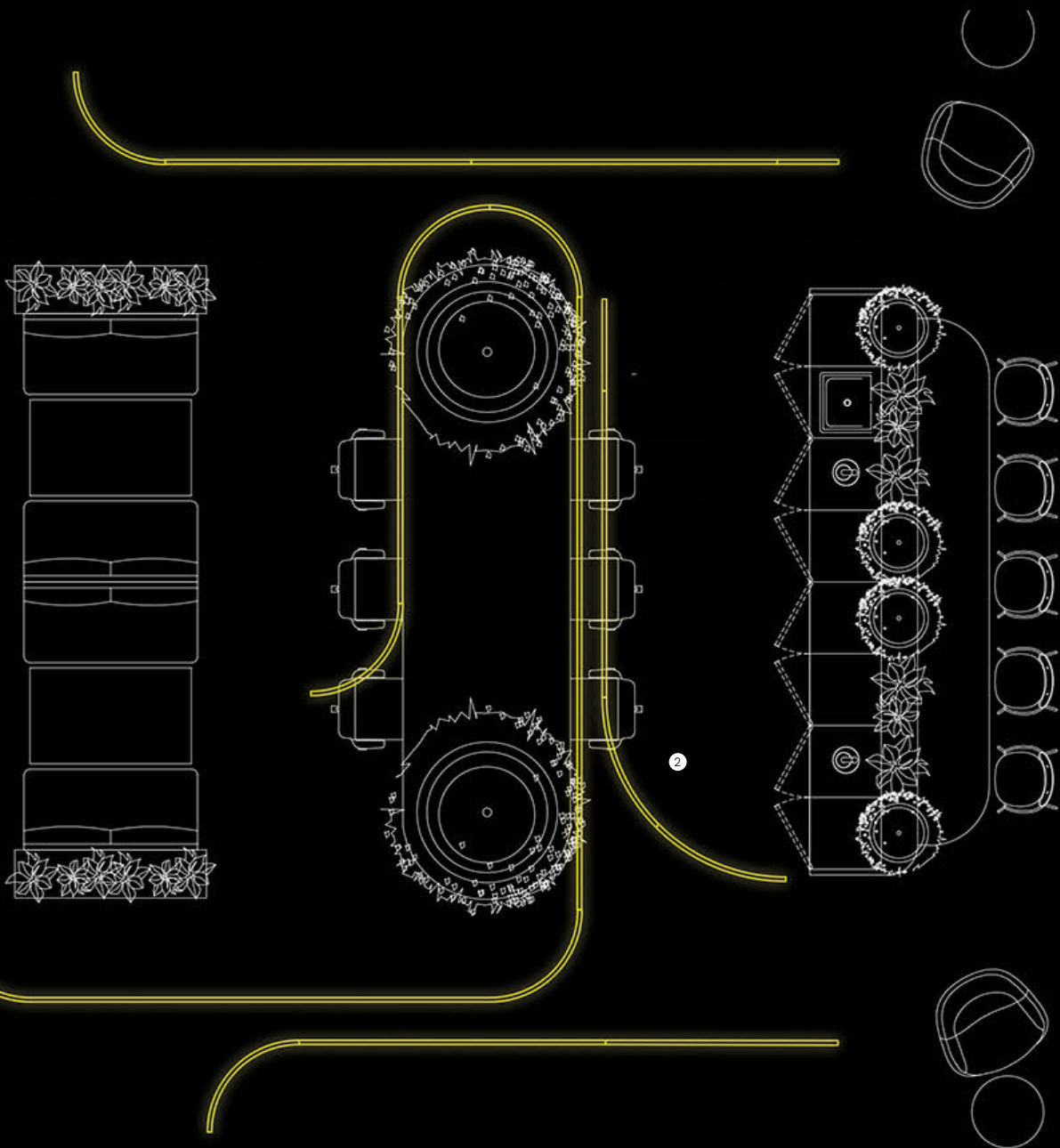

1



2



To discuss your project and get started, simply contact [support@ricoman.com](mailto:support@ricoman.com)

**Astrowave the flexible  
360° neon light system.**



Let your  
imagination

on flow.

# Astrowave



Dimensions in mm

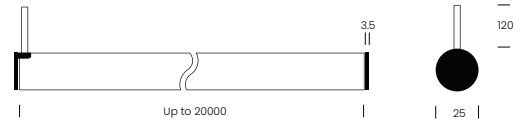

Finish	White or Black
CRI	>90 Ra
Beam Angle	360°
Operating Hours	50000
IP Rating	IP65

**Length**      **/XM**  
 X=metres needed

Model	1000	2000	/SPI	/RGB
	Up to 5M standard	Up to 20M standard	Pixel addressable	RGB
Voltage	24V	Voltage 48V	Voltage 12V	Voltage 24V
Wattage	14.4W/M	Wattage 12.5W/M	Wattage 21.6W/M	Wattage 14.4W/M

**Colour Finish**      **/WT**      **/BK**  
 White      Black  
 Only available for RGB & SPI options.

**Options**      **/ECE**      **/SE**  
 End Cap Entry      Side Entry

Kelvin	/23K	/27K	/3K	/4K	/SPI	/RGB
	2300K	2700K	3000K	4000K	Pixel addressable	RGB

**Code Example**      R75I000/ECE/27K- 24V Standard Astrowave with end cap entry in 2700K.

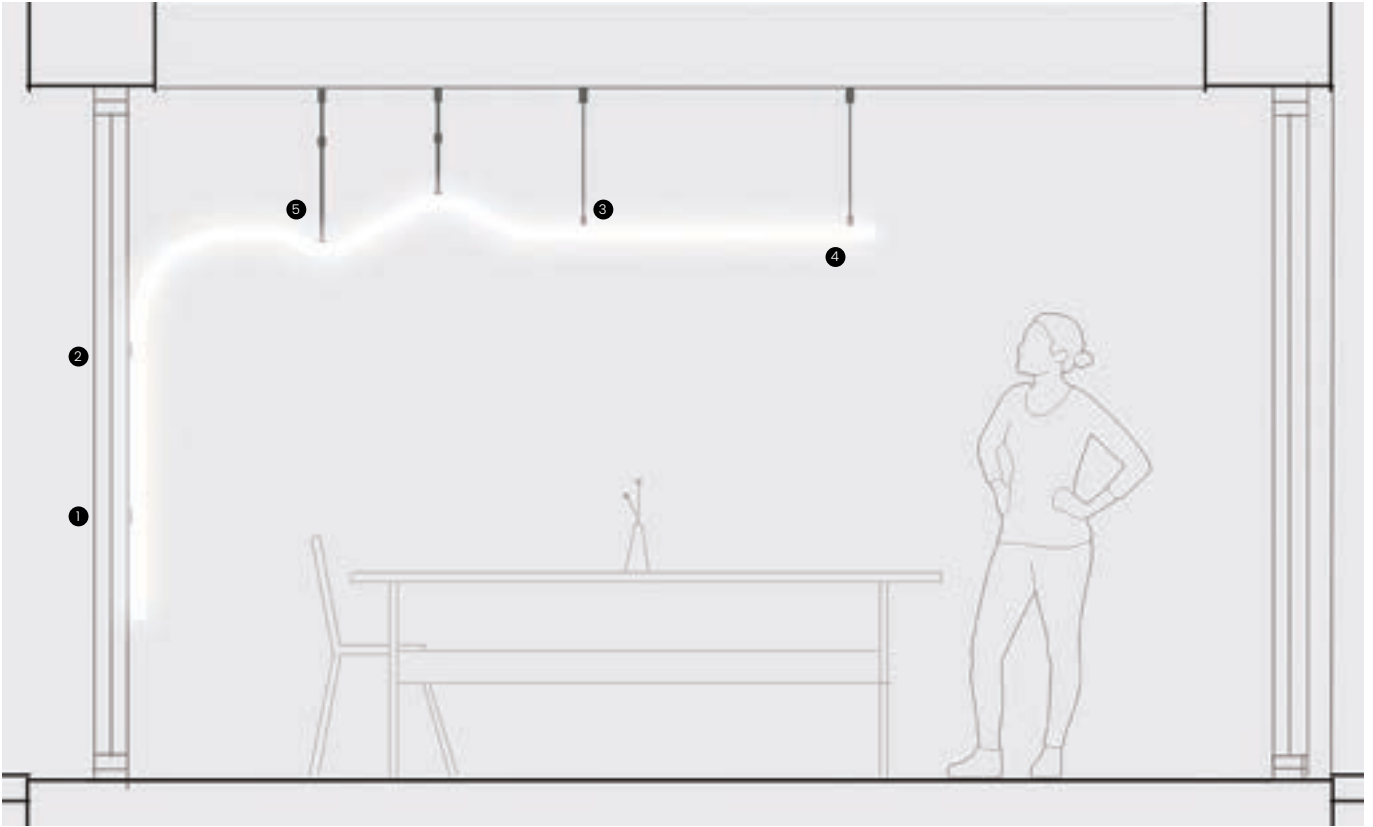

**Horizontal suspended and surface options**

**Accessories**



**R75-03**  
Astrowave surface mounting kit

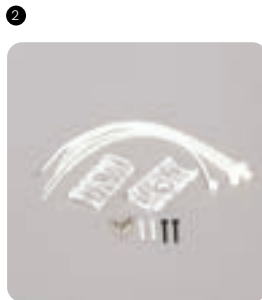

**R75-04**  
Astrowave concealed surface mounting kit

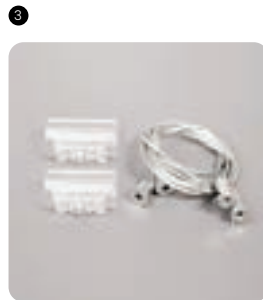

**R75-05**  
Astrowave horizontal suspension kit

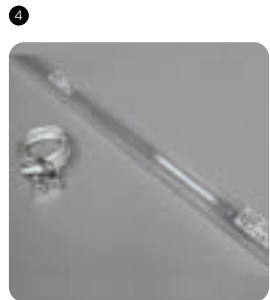

**R75-10**  
Astrowave horizontal suspension kit with acrylic tube



**R75-01**  
Astrowave adjustable solid rod mounting kit

# Astrowave

The IP65 flexible 360° neon light system, Astrowave is a versatile and creative lighting solution that can be used as pendant or mounted on walls and ceilings.

Explore all the possibilities by creating 25mm diameter lines of light. From ambient lighting to accent lighting, Astrowave can turn any installation to a genuine architectural creation.

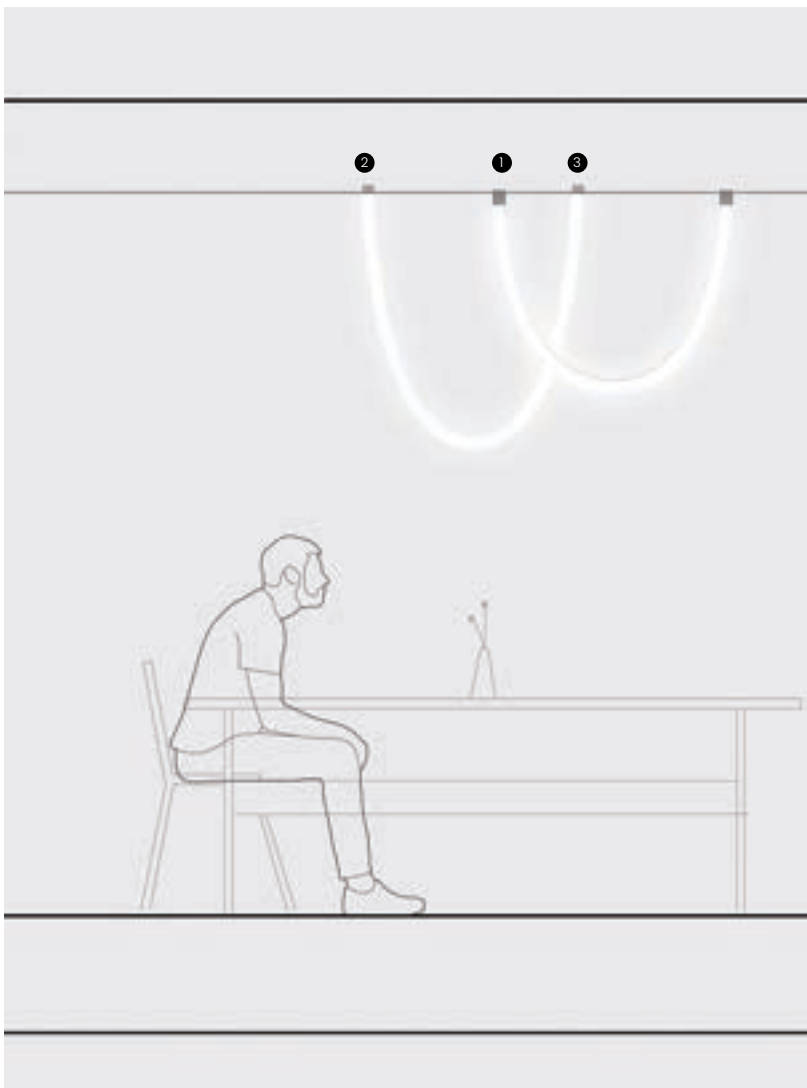

## Two point mounting

### Accessories

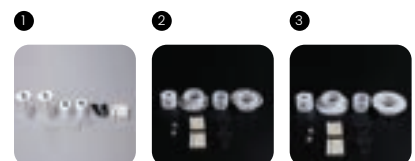

**R75-02**

Astrowave end  
cap surface  
mounting kit

**R75-15**

Astrowave plaster  
in recessed kit

**R75-16**

Astrowave  
recessed kit

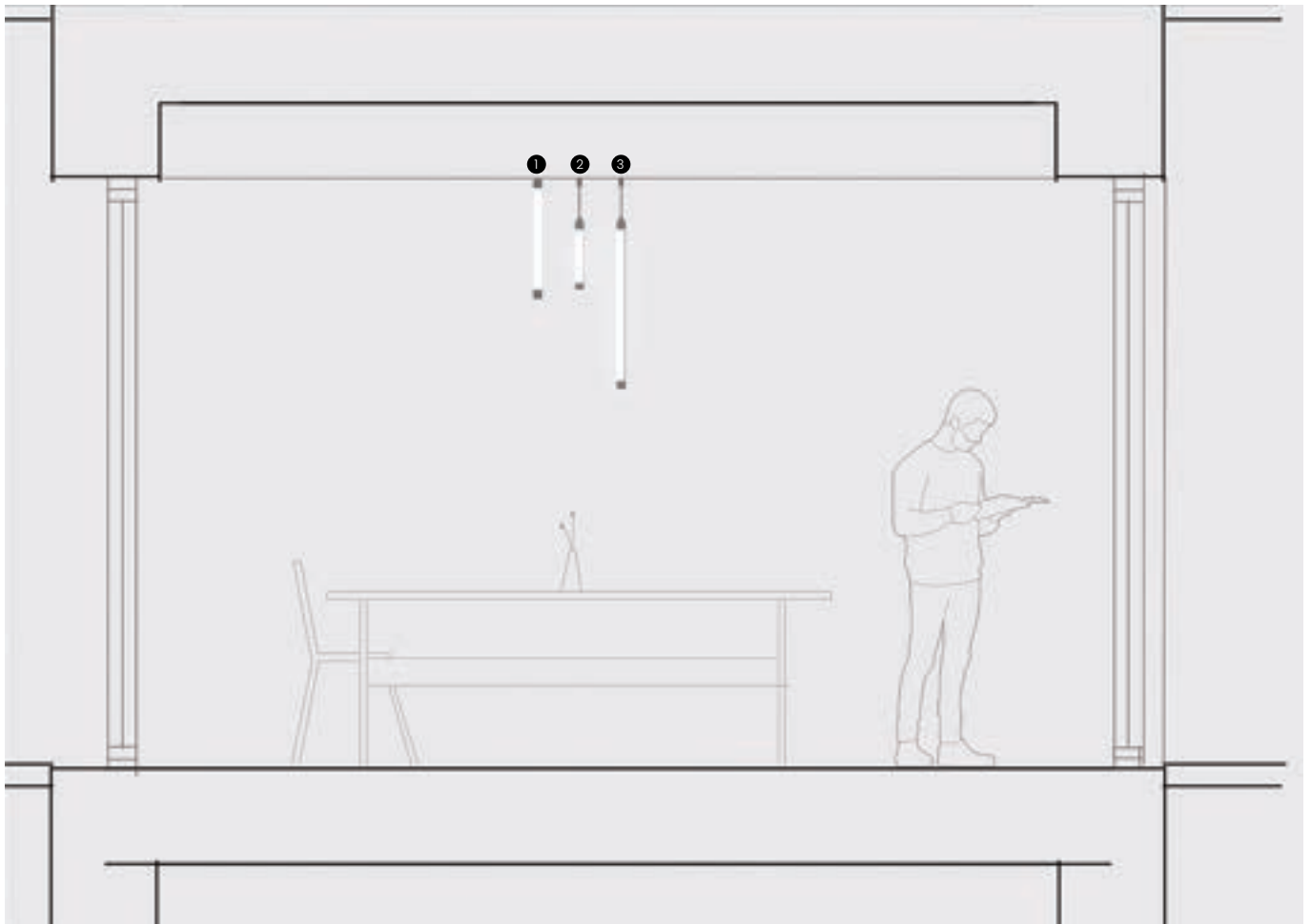

**Vertical surface or suspended options**

**Accessories**

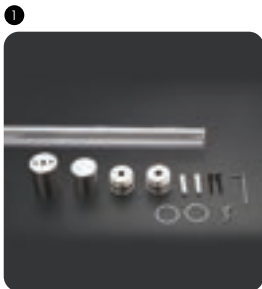

**R75-06**  
Astrowave 1m  
long linear  
pendant  
mounting kit

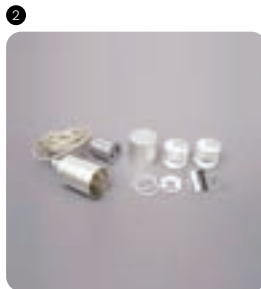

**R75-08**  
Astrowave  
vertical  
suspension kit



**R75-09**  
Astrowave  
vertical  
suspension kit  
with 2.5m acrylic  
tube

R75\_-----

# Astrowave



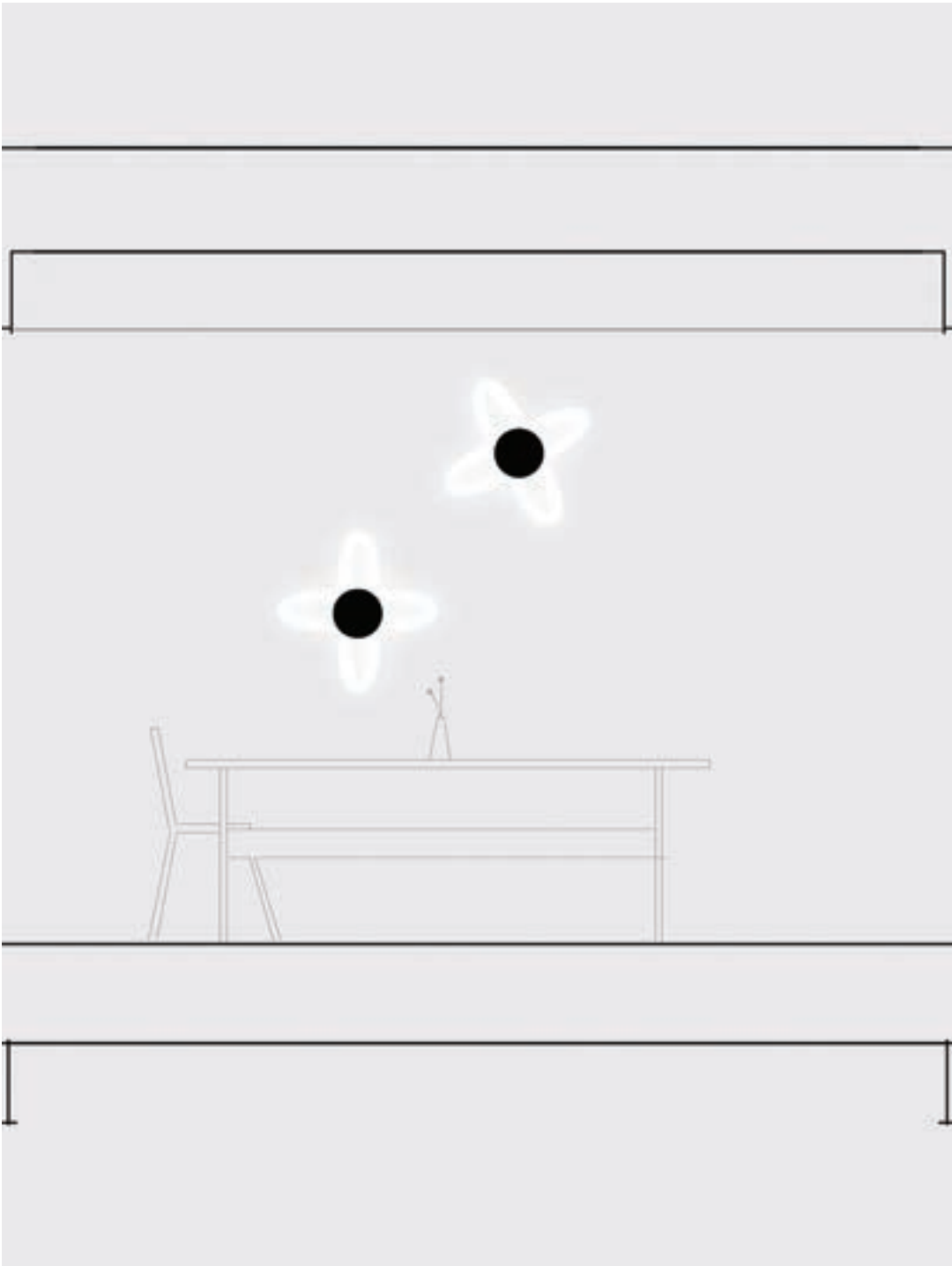

**Decorative mounting**

**Accessories**



**R75-12**  
Astrowave  
node plate



**R75-13**  
Astrowave  
single node



**R75-14**  
Astrowave  
double node

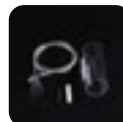

**R75-17**  
Astrowave  
horizontal  
suspension  
connection



**R75-07**  
Astrowave  
Connection kit

R7101\_\_

# Neon Flex

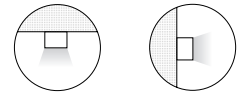

Neon Flex is a flexible and creative 12mm wide sleek smooth light line that can flow and flex to create unique light shapes. Suitable for indoors or outdoors applications, IP66 as standard with an option of IP68 as a special order. Available as top or side bend.



3 YR  
WARRANTY

Dimensions in mm



Wattage	12W
Lumen	700lm/m
Finish	PVC
Kelvin	3000K
CRI	>80 Ra
Beam Angle	180°
Operating Hours	50,000
SDCM	≤4
L70 B50	100,000 hours

IP rating	<b>01</b>	<b>02</b>
	IP66	IP68

Options	<b>/DH</b>	<b>/DD</b>	<b>/DL</b>	<b>/DSI</b>
	Mains dimings	DALI dimming	0-10V dimming	DSI dimming

**Code Example** R7101/DD- 5000mm Neon flex IP66 with DALI dimming.



# Aeroline

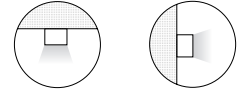

Aeroline series includes unobtrusive mini LED light lines boasting an ultra slim 8mm profile and only 18mm width. Ideal for under cabinet kitchen lighting, retail, display or refrigeration lighting, the series features a number of options to explore.



Dimensions in mm

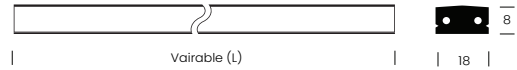

Finish	Aluminium
Kelvin	3000K / 6000K
CRI	>82 Ra
Beam Angle	40°
Operating Hours	50,000
SDCM	≤4
L70 B50	70,000 hours
IP Rating	IP20

**Length**

<b>01</b> 150mm length		<b>02</b> 300mm length		<b>03</b> 600mm length		<b>04</b> 900mm length		<b>05</b> 1000mm length	
Efficacy	<b>84Lm/W</b>	Efficacy	<b>75Lm/W</b>	Efficacy	<b>70Lm/W</b>	Efficacy	<b>71Lm/W</b>	Efficacy	<b>70Lm/W</b>
Wattage	<b>2.5W</b>	Wattage	<b>5W</b>	Wattage	<b>9W</b>	Wattage	<b>14W</b>	Wattage	<b>15W</b>

<b>06</b> 1200mm length	
Efficacy	<b>69Lm/W</b>
Wattage	<b>16W</b>

Kelvin	<b>01</b>	<b>02</b>
	3000K	6000K

**Code Example** R240101- 150mm length 2.5W Aeroline in 3000K.

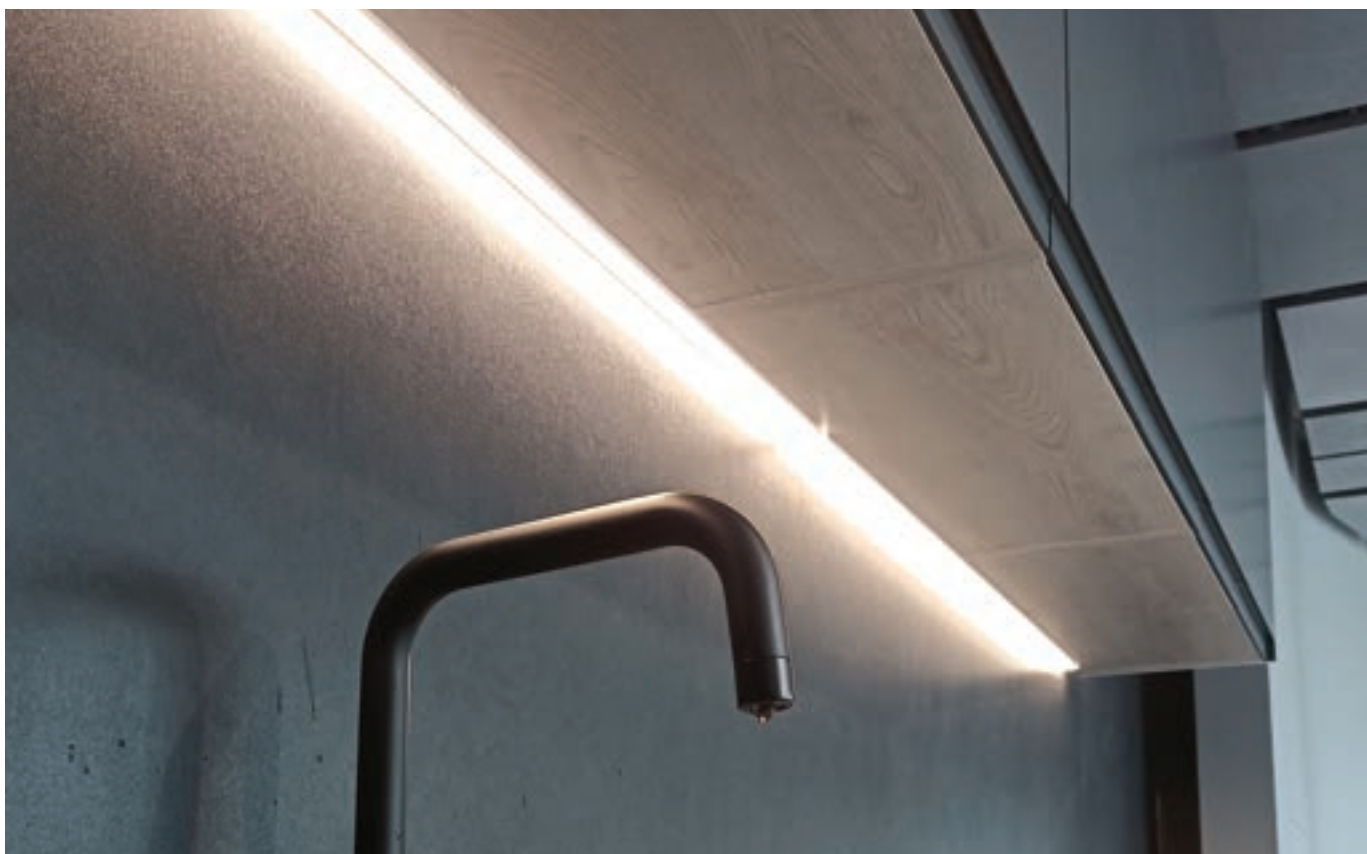

**Accessories**

<b>R24-01</b>	Fixing clip with screws, for 90° installation
<b>R24-02</b>	Fixing clip with screws, for 180° installation
<b>R24-03</b>	Middle connector
<b>R24-04</b>	Left 'L' corner connector
<b>R24-05</b>	T' corner connector
<b>R24-06</b>	'+' corner connector
<b>R24-07</b>	Right 'L' corner connector
<b>R24-08</b>	Solid 'L' corner connector
<b>R36-09/2.5M</b>	Input power line
<b>R36-10</b>	1m extension cable
<b>R36-11</b>	Hand by hand connector
<b>R36-12</b>	1 v 4 adaptor junction cable
<b>R36-13</b>	Touch switch
<b>R36-14</b>	Sensor switch
<b>R36-15</b>	Dimmer switch
<b>R36-16</b>	End cap
<b>R36-17</b>	Magnet, metal plate and 3M tape
<b>R36-18</b>	Side power entry point

Photo: **Studio Power, Architect Offices** in Salford.

# COB Ricostrip

A COB LED strip offering IP20 or IP65 options. The flexible light strip is available in four colour temperatures as low as 2700K and up to 6500K with a maximum of 1000 lumens per metre and 104 lumens per watt. Ricostrip is versatile and ideal for many different decorative lighting applications.



Dimensions in mm

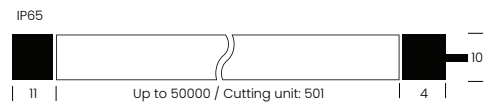
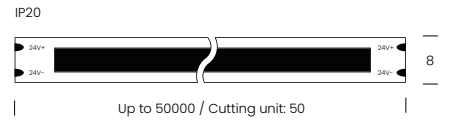

CRI	>82 Ra
Beam Angle	40°
Operating Hours	50,000
SDCM	≤4
L70 B50	70,000 hours

<b>Kelvin</b>	<b>/27K</b>	<b>/3K</b>	<b>/4K</b>	<b>/65K</b>
	2700K	3000K	4000K	6500K

<b>IP Rating</b>	<b>/IP20</b>	<b>/IP65</b>
	IP20 rating	IP65 rating

**Size**      **/XM**  
 X=metres needed

<b>Options</b>	<b>/CC</b>	<b>/DD</b>	<b>/DL</b>	<b>/DSI</b>
	CASAMBI controls	DALI dimming	0-10V dimming	DSI dimming

**Code Example**      R081010/4K/IP65/3M/CC - Ricostrip COB 4000K IP65, 3m size Casambi control.

**Accessories**



**R08-01**  
 Ricostrip Straight  
 Electrical  
 Connector

**R08-02**  
 Ricostrip L  
 Electrical  
 Connector

# SMD Ricostrip

A SMD LED strip offering a standard or high output version. The high output comes in IP20 or IP65 options. The flexible light strip is available in five colour temperatures as low as 1900K and up to 6000K with a maximum of 1630 lumens per metre and 127 lumens per watt. Ricostrip is versatile and ideal for many different decorative lighting applications.

Dimensions in mm

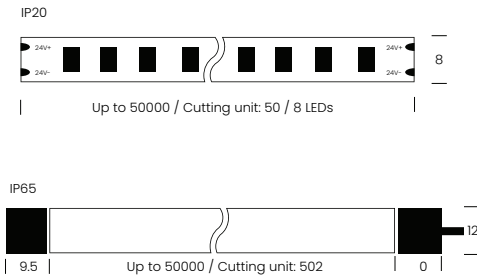

CRI	>82 Ra
Beam Angle	40°
Operating Hours	50,000
SDCM	≤4
L70 B50	70,000 hours

<b>Kelvin</b>	<b>/19K</b>	<b>/23K</b>	<b>/3K</b>	<b>/4K</b>	<b>/6K</b>
	1900K	2300K	3000K	4000K	6000K

<b>Output</b>	<b>/SO</b>	<b>/HO</b>
	10.8W/M	13W/M

<b>IP Rating</b>	<b>/IP20</b>	<b>/IP65</b>
	IP20 rating	IP65 rating (Only available for High Output)

<b>Size</b>	<b>/XM</b>
	X=metres needed

<b>Options</b>	<b>/CC</b>	<b>/DD</b>	<b>/DL</b>	<b>/DSI</b>
	CASAMBI controls	DALI dimming	0-10V dimming	DSI dimming

**Code Example** R081020/6K/HO/IP65/3M- Ricostrip SMD 6000K high output IP65, 3m size.

**Accessories**



**R08-01**  
Ricostrip Straight Electrical Connector



**R08-02**  
Ricostrip L Electrical Connector







# Prosperity 24/7 HQ, workspace in Jersey.

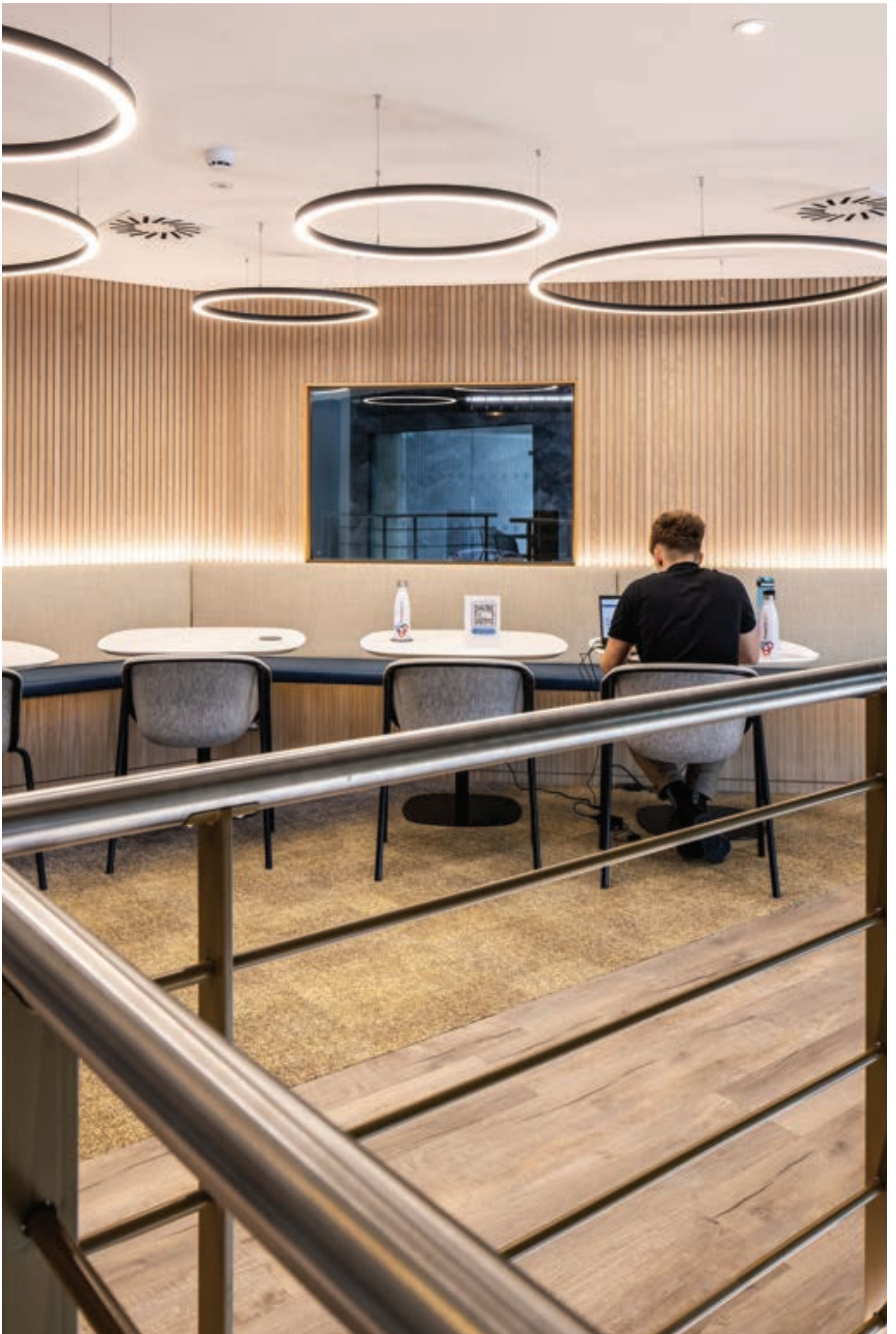

At Prosperity 24/7 HQ, RICOMAN supplied **Flow Downwards Ring** pendants, tailored to suit both suspended and surface-mounted configurations.

These sleek and modern fixtures provided efficient illumination, enhancing the workspace with a blend of style and functionality.







# Pendant lighting

R3617\_---

# Flow Ring downwards lighting



A modern pendant or surface mounted ring luminaire in 0.8m or 1.5m diameter. Suitable for use in different environments, it can be used as a single luminaire or in combination for general and feature lighting. It is available with outwards, inward and downwards lighting in white, black or silver finish and 3000K, 4000K and RGB.



Dimensions in mm

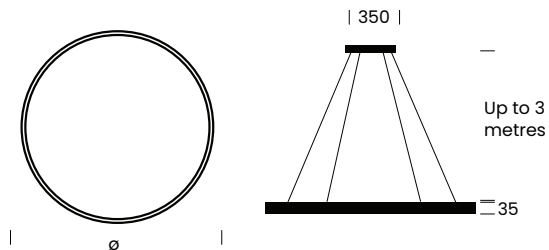

Efficacy	57Lm/W
CRI	>90 Ra
Beam Angle	120°
Operating Hours	50,000
SDCM	≤3
L70 B50	100,000 hours
IP Rating	IP20

Size	80	150
Size	ø835 x 35 x 35	Size ø1535 x 35 x 35
Wattage	50W	Wattage 90W

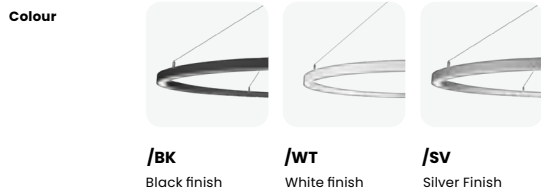

Kelvin	<b>/3K</b> 3000K	<b>/4K</b> 4000K	<b>/RGBW</b> RGBW
--------	---------------------	---------------------	----------------------

**Code Example** R3617150/BK/3K - Black 1535mm Ring Lighting Downwards 90W in 3K



**Prosperity 24/7 HQ**, workspace in Jersey.  
Product: Flow Downward Ring Pendant

R3637\_---

# Flow Ring inwards lighting

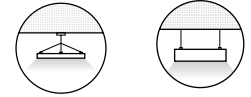

A modern pendant or surface mounted ring luminaire with inwards lighting direction. Suitable for use in different environments, it can be used as a single luminaire or in combination for general and feature lighting. It is available in white, black or silver finish and 3000K or 4000K.



Dimensions in mm

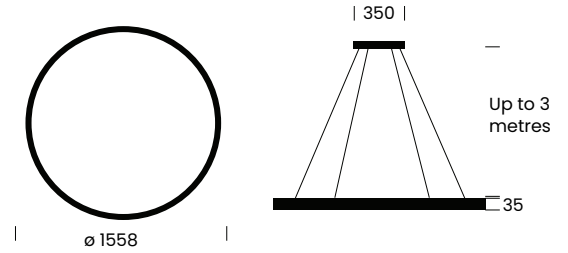

Efficacy	57Lm/W
CRI	>90 Ra
Beam Angle	120°
Operating Hours	50,000
SDCM	≤3
L70 B50	100,000 hours
IP Rating	IP20

## Size 150

Size	ø1558 x 35 x 35
Wattage	99W

## Colour



- /BK**  
Black finish
- /WT**  
White finish
- /SV**  
Silver Finish

## Kelvin

- /3K**  
3000K
- /4K**  
4000K

**Code Example** R3637150/WT/3K - Flow inwards ring in white finish and 3000K

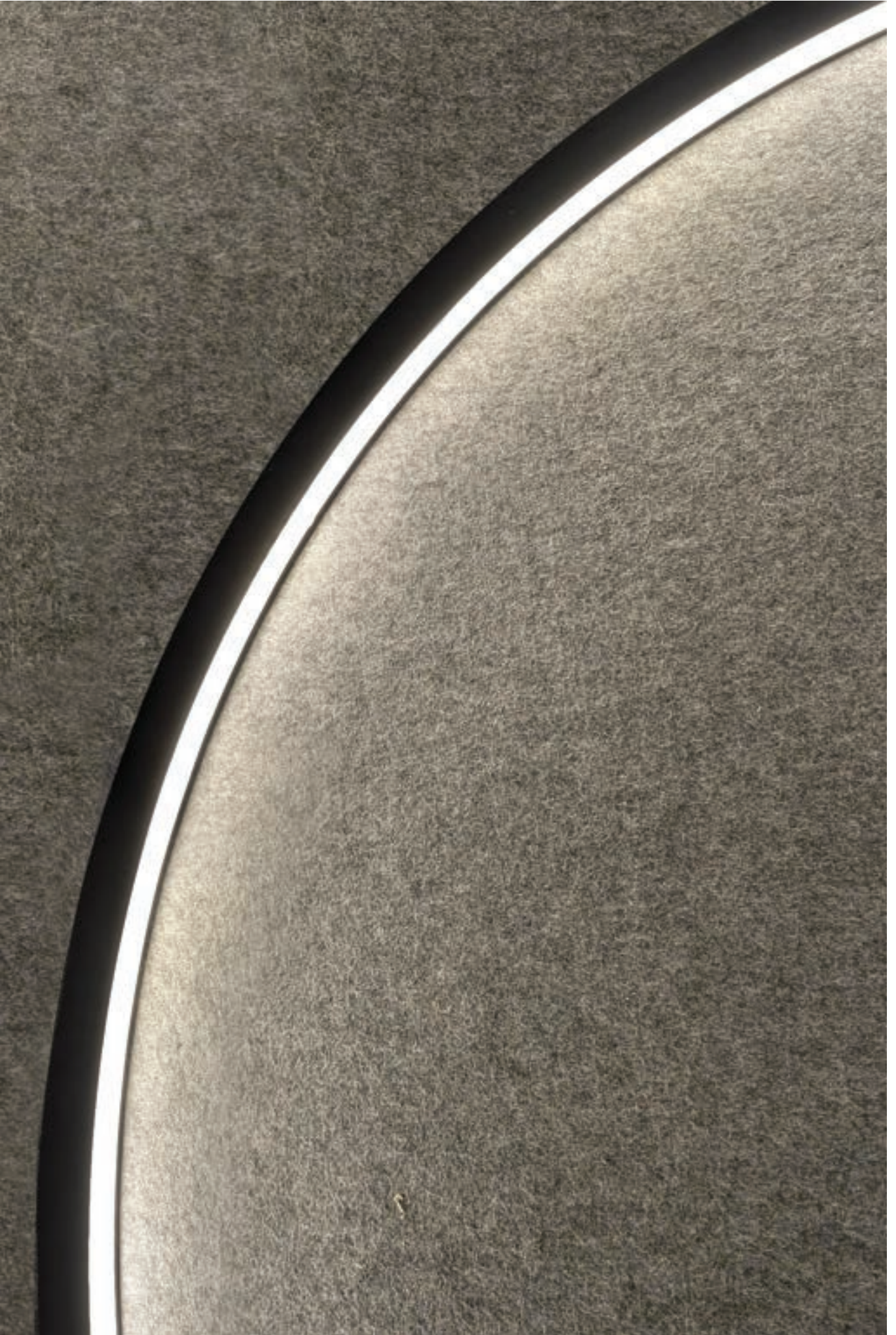

R3627\_---

# Flow Ring outwards lighting

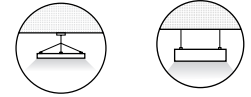

A modern pendant or surface mounted ring luminaire with outwards lighting direction. Suitable for use in different environments, it can be used as a single luminaire or in combination for general and feature lighting. It is available in white, black or silver finish and 3000K or 4000K.

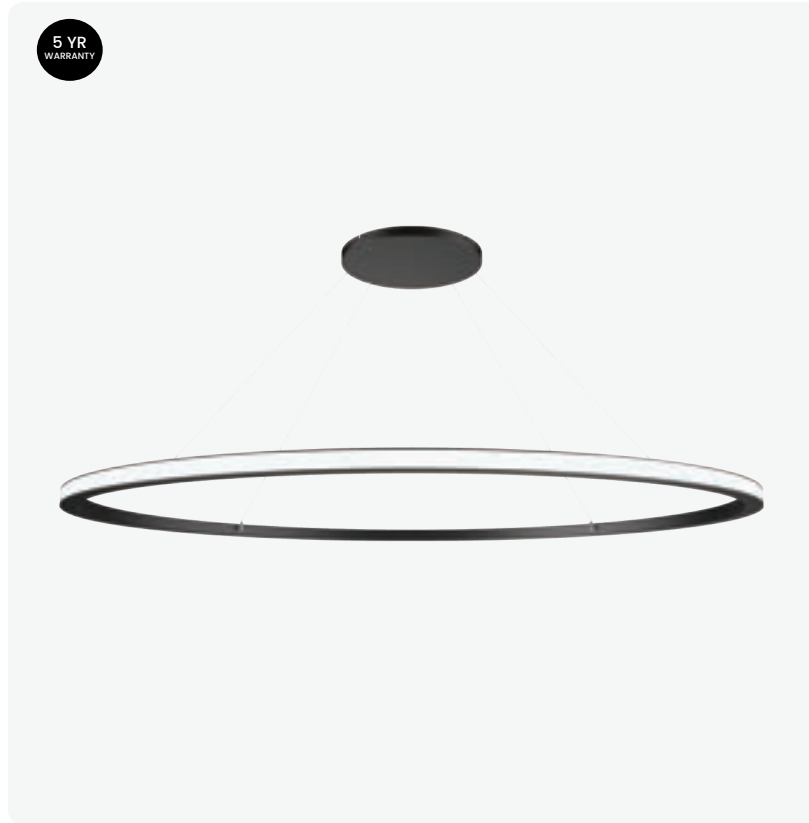

Dimensions in mm

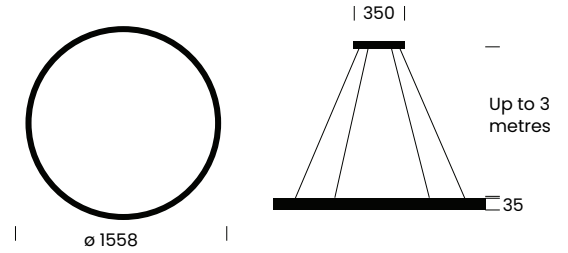

Efficacy	57lm/W
CRI	>90 Ra
Beam Angle	120°
Operating Hours	50,000
SDCM	≤3
L70 B50	100,000 hours
IP Rating	IP20

## Size 150

Size	ø1558 x 35 x 35
Wattage	99W

## Colour



**/BK**  
Black finish

**/WT**  
White finish

**/sv**  
Silver Finish

## Kelvin

**/3K**  
3000K

**/4K**  
4000K

**Code Example** R3627150/WT/3K - 1558mm Ring Lighting Outwards in white finish and 3000K

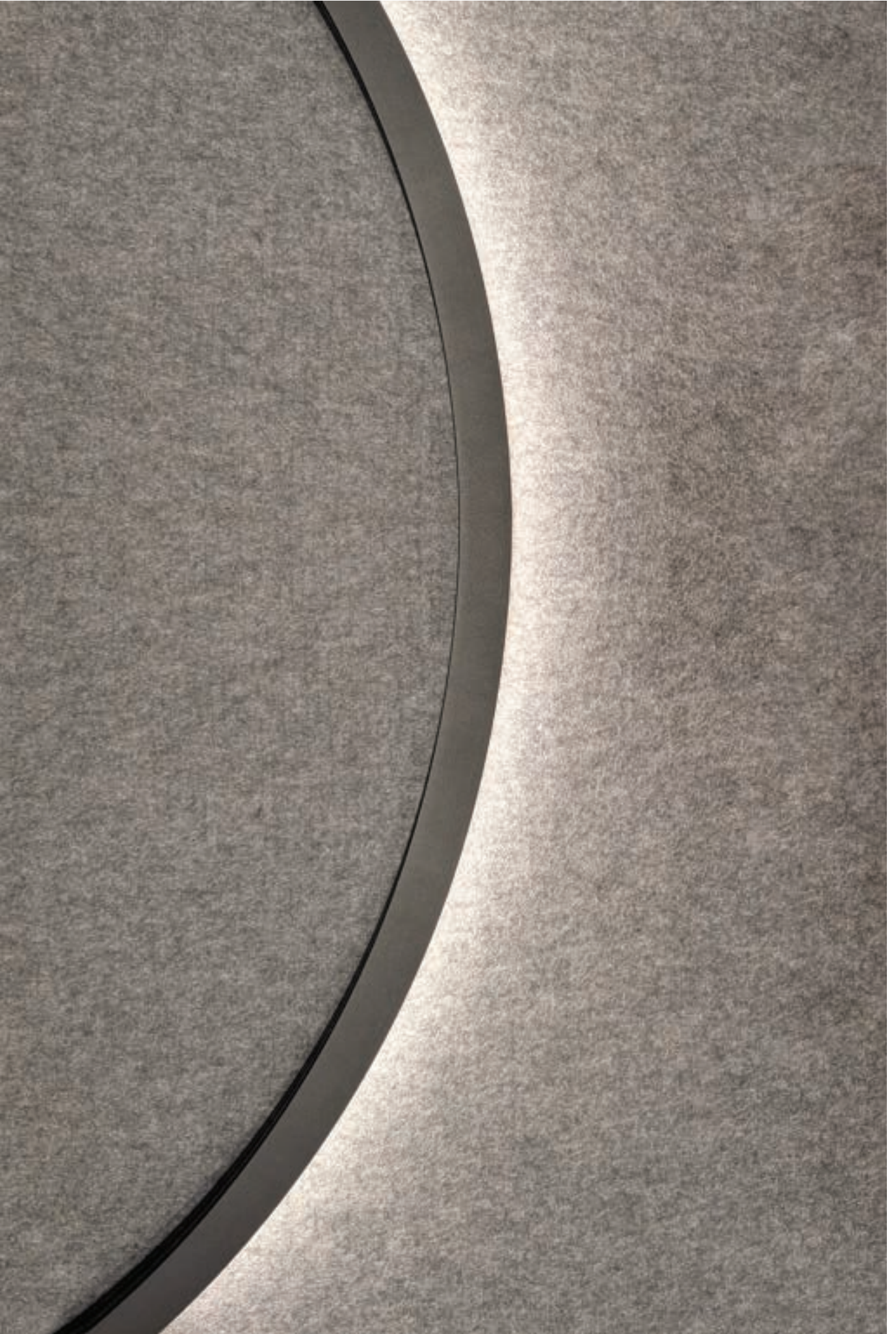

# Sounds Like Light acoustic lighting.

A **sound absorbing** eco-friendly linear lighting solution. Sounds Like Light has an OEKO-TEX® certification and Class A absorption. Explore a stunning selection of 22 colours available in four linear lengths, from 607mm to 2204mm.

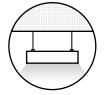

Sounds Like Light baffles are classed as **Class A** absorption. NRC (Noise Reduction Coefficient) is a measure, represented as a decimal between 0 and 1, that indicates how well a material absorbs sound. Higher values, closer to 1, signify better sound absorption. NRC is commonly used to assess and compare the acoustic performance of materials, with higher values being preferable in environments where reducing reverberation and improving speech intelligibility are key.

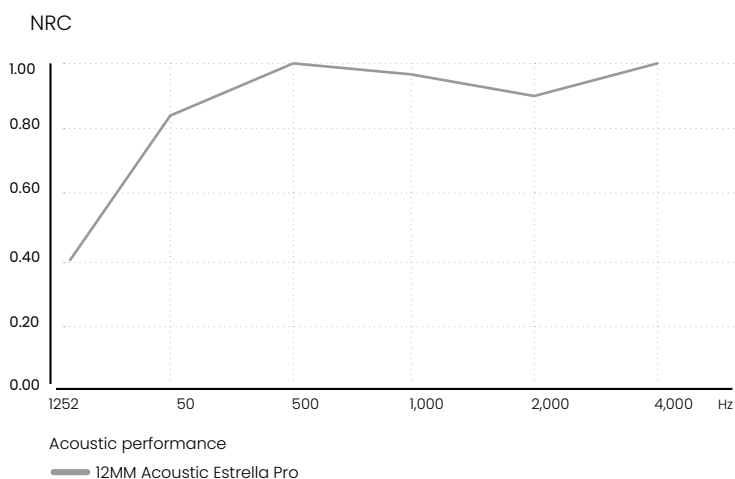



**Size**

**05**  
Short Baffle

Size	<b>L607 x W78 x H160</b>
Wattage	<b>14W</b>

**11**  
Medium Baffle

Size	<b>L1139 x W78 x H160</b>
Wattage	<b>28W</b>

**16**  
Long Baffle

Size	<b>L1672 x W78 x H160</b>
Wattage	<b>42W</b>

**21**  
Extra Long Baffle

Size	<b>L2204 x W78 x H160</b>
Wattage	<b>56W</b>

**Model**



**00**  
Baffle Only



**01**  
Baffle and Light with Opal Diffuser

Efficacy	<b>125Lm/W</b>
Beam Angle	<b>100°</b>



**02**  
Baffle and Light with Square Aperture Diffuser

Efficacy	<b>125Lm/W</b>
Beam Angle	<b>90°</b>



**03**  
Baffle and Light with Round Aperture Diffuser

Efficacy	<b>125Lm/W</b>
Beam Angle	<b>50°</b>



**04**  
Baffle and Light with Wallwash Diffuser

Efficacy	<b>116Lm/W</b>
Beam Angle	<b>60°</b>



**05**  
Baffle and Light with Black Louvre

Efficacy	<b>75Lm/W</b>
Beam Angle	<b>70°</b>



**06**  
Baffle and Light with Mirror Louvre

Efficacy	<b>96Lm/W</b>
Beam Angle	<b>70°</b>



**07**  
Baffle and Light with White Louvre Diffuser

Efficacy	<b>104Lm/W</b>
Beam Angle	<b>70°</b>



**09**  
Baffle and Light with UGR Diffuser

Efficacy	<b>100Lm/W</b>
Beam Angle	<b>100°</b>

<b>Kelvin</b>	<b>/27K</b>	<b>/3K</b>	<b>/4K</b>
	2700K	3000K	4000K

## Sounds Like Light acoustic lighting

Sounds Like Light Acoustic Baffle is a simple way to design your working environment or personal space the way you like it. With **22 standard colours** to select from, we will have the right colour and design for you.

### Colour Finish



**Code Example** R641107/SLL03/4K/28W/DD - Sounds Like Light Medium 28W Light Baffle in camel ivory finish, with white Louvre Optics, in 4000K and DALI dimming.



# Sounds Like Light Echo Pendant

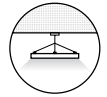

Echo is a modern acoustic pendant with a large shade made of thick and durable PET felt material. The sleek shade has a soft appearance, with subtle folds at the top. The light source is concealed within a white reflector inside the felt shade. This provides a soft, diffused light, preventing glare and giving a sleek and clean look.



5 YR WARRANTY

Dimensions in mm

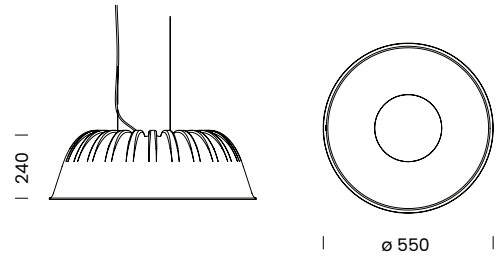

Lamp	E27
Material	Polyester - PET
IP Rating	IP20
NRC	0.85

Colour Finish



- /AC-01/5mm**  
Sounds Like Light  
Pendants 5mm  
Red
- /AC-10/5mm**  
Sounds Like Light  
Pendants 5mm  
Khaki
- /AC-14/5mm**  
Sounds Like Light  
Pendants 5mm  
Gold
- /AC-16/5mm**  
Sounds Like Light  
Pendants 5mm  
Dark Blue
- /AC-22/5mm**  
Sounds Like Light  
Pendants 5mm  
Moss Green



- /AC-31/5mm**  
Sounds Like Light  
Pendants 5mm  
Black
- /AC-34/5mm**  
Sounds Like Light  
Pendants 5mm  
Anthracite
- /AC-35/5mm**  
Sounds Like Light  
Pendants 5mm  
Light Grey

**Code Example** R649201/AC-35/5mm- Sounds Like Light Echo Pendant in 5mm light grey.

# Sounds Like Light Melody Pendant

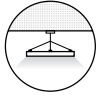



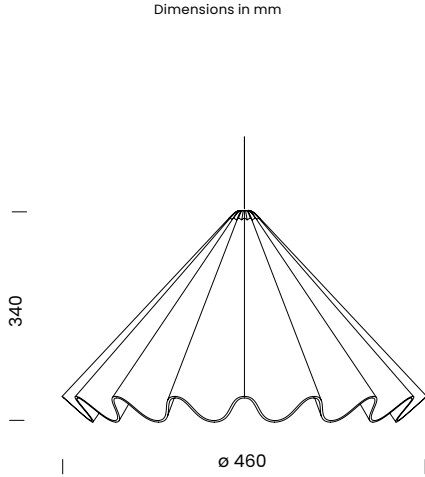





Melody is a contemporary pendant light that blends a conical silhouette with softened, rounded edges. This gives a nice architectural feeling making it suitable from commercial and domestic use. The lamp is discreetly concealed within the shade. This delivers a focused downward illumination with a gentle glow through the felt material.



Lamp	E27
Material	Polyester - PET
IP Rating	IP20
NRC	0.85

**Colour Finish**

				
<b>/AC-01/5mm</b> Sounds Like Light Pendants 5mm Red	<b>/AC-10/5mm</b> Sounds Like Light Pendants 5mm Khaki	<b>/AC-14/5mm</b> Sounds Like Light Pendants 5mm Gold	<b>/AC-16/5mm</b> Sounds Like Light Pendants 5mm Dark Blue	<b>/AC-22/5mm</b> Sounds Like Light Pendants 5mm Moss Green
				
<b>/AC-31/5mm</b> Sounds Like Light Pendants 5mm Black	<b>/AC-34/5mm</b> Sounds Like Light Pendants 5mm Anthracite	<b>/AC-35/5mm</b> Sounds Like Light Pendants 5mm Light Grey		

**Code Example** R649203/AC-35/5mm- Sounds Like Light Melody Pendant in 5mm light grey.

# Sounds Like Light Chorus Pendant

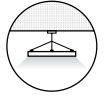

Chorus is a unique pendant light that blends natural materials with a simple and functional design. The key element is the subtle use of wood at the top of the shade. This adds a touch of natural warmth and contrast to the PET felt texture.



Dimensions in mm

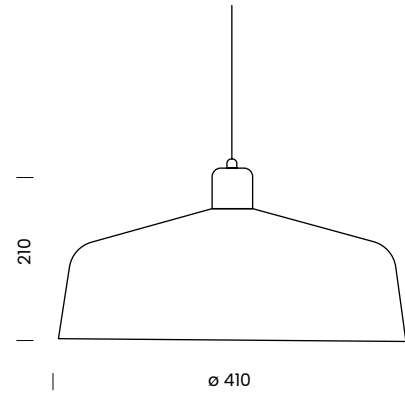

Lamp	E27
Material	Polyester - PET
IP Rating	IP20
NRC	0.85

Colour Finish



- /AC-01/5mm**  
Sounds Like Light  
Pendants 5mm  
Red
- /AC-10/5mm**  
Sounds Like Light  
Pendants 5mm  
Khaki
- /AC-14/5mm**  
Sounds Like Light  
Pendants 5mm  
Gold
- /AC-16/5mm**  
Sounds Like Light  
Pendants 5mm  
Dark Blue
- /AC-22/5mm**  
Sounds Like Light  
Pendants 5mm  
Moss Green



- /AC-31/5mm**  
Sounds Like Light  
Pendants 5mm  
Black
- /AC-34/5mm**  
Sounds Like Light  
Pendants 5mm  
Anthracite
- /AC-35/5mm**  
Sounds Like Light  
Pendants 5mm  
Light Grey

**Code Example** R649208/AC-35/5mm- Sounds Like Light Chorus Pendant in 5mm light grey.

# Sounds Like Light Whisper Pendant

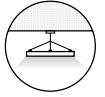



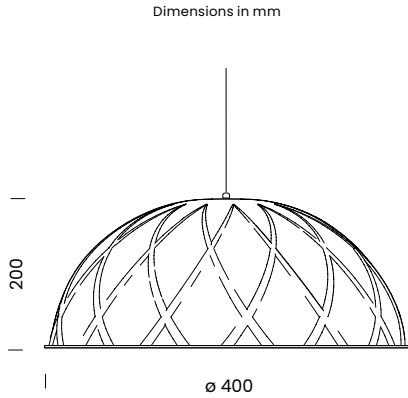





Whisper's large, dome-shaped shade is a visual statement, ideal for open-plan spaces. This form is both aesthetically appealing and functional, providing a broad surface area for sound absorption. The subtle, textured pattern on the shade adds visual interest and depth to this pendant light, blending classic sophistication with contemporary elements.



5 YR  
WARRANTY

Lamp	E27
Material	Polyester - PET
IP Rating	IP20
NRC	0.85

Colour Finish

				
<b>/AC-01/5mm</b> Sounds Like Light Pendants 5mm Red	<b>/AC-10/5mm</b> Sounds Like Light Pendants 5mm Khaki	<b>/AC-14/5mm</b> Sounds Like Light Pendants 5mm Gold	<b>/AC-16/5mm</b> Sounds Like Light Pendants 5mm Dark Blue	<b>/AC-22/5mm</b> Sounds Like Light Pendants 5mm Moss Green
				
<b>/AC-31/5mm</b> Sounds Like Light Pendants 5mm Black	<b>/AC-34/5mm</b> Sounds Like Light Pendants 5mm Anthracite	<b>/AC-35/5mm</b> Sounds Like Light Pendants 5mm Light Grey		

**Code Example** R649209/AC-35/5mm- Sounds Like Light Whisper Pendant in 5mm light grey.

# Sounds Like Light Pitch Pendant

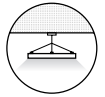

Pitch seamlessly combines a soft, fabric-like appearance with sleek metallic accents, resulting to an industrial yet cosy aesthetic. Its dome design ensures this pendant light has both an efficient sound absorption and a contemporary look.

Lamp	E27
Material	Polyester - PET
IP Rating	IP20
NRC	0.85

## Colour Finish



<b>AC-01/5mm</b> Sounds Like Light Pendants 5mm Red	<b>/AC-10/5mm</b> Sounds Like Light Pendants 5mm Khaki	<b>/AC-14/5mm</b> Sounds Like Light Pendants 5mm Gold	<b>/AC-16/5mm</b> Sounds Like Light Pendants 5mm Dark Blue	<b>/AC-22/5mm</b> Sounds Like Light Pendants 5mm Moss Green	<b>/AC-31/5mm</b> Sounds Like Light Pendants 5mm Black	<b>/AC-34/5mm</b> Sounds Like Light Pendants 5mm Anthracite	<b>/AC-35/5mm</b> Sounds Like Light Pendants 5mm Light Grey
--	---	--	---	--	---	--	--

Model



**/800**  
Pitch Round - 800mm

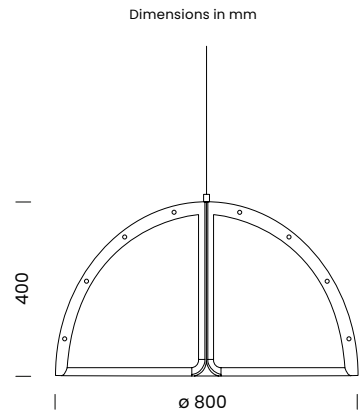

**/1600**  
Pitch Oval - 1600mm

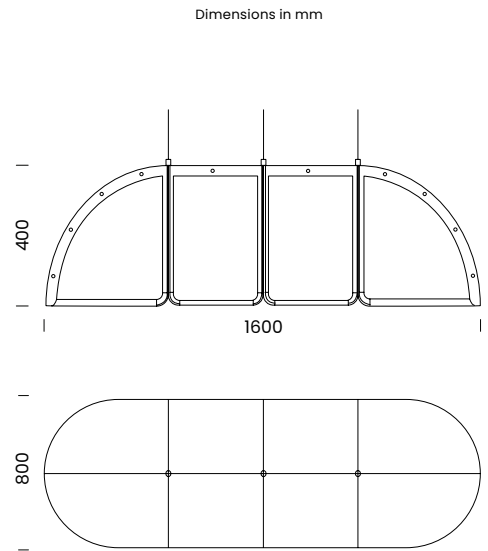

**Code Example** R649211/800/AC-35/5mm - Sounds Like Light Pitch Round 800mm Pendant in 5mm light grey.

# Sounds Like Light Ensemble Pendant

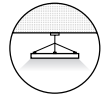

Ensemble features a bold, modern design with a series of evenly spaced vertical slats forming a streamlined, capsule silhouette. The structure gives it a sculptural and architectural presence while incorporating effective acoustic properties. The light source is a linear light with Samsung LED chips, known for longevity and high performance.

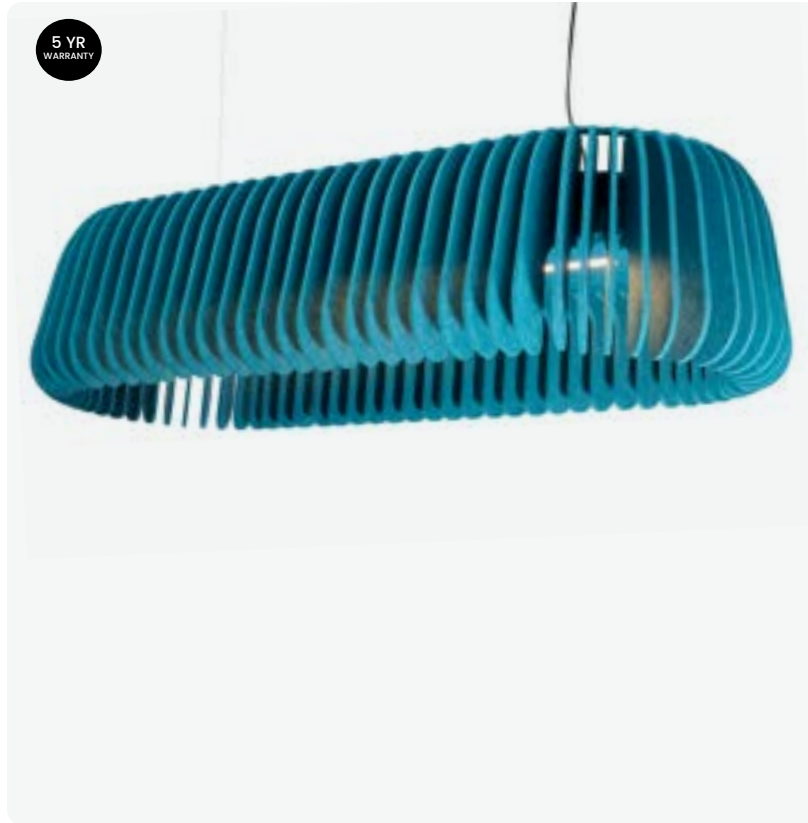



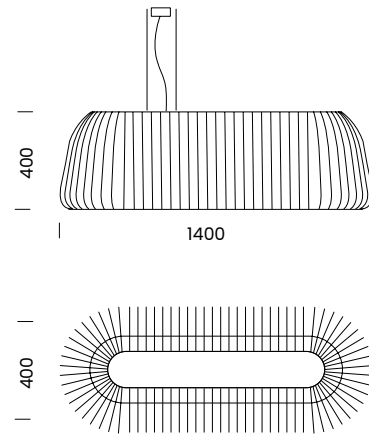





Dimensions in mm

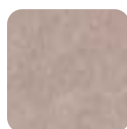

Efficacy	120 Lm/W
NRC	0.91
CRI	>90 Ra
Beam Angle	100°
Operating Hours	50,000
SDCM	≤3
IP Rating	IP20

<b>Kelvin</b>	<b>/3K</b> 3000K	<b>/4K</b> 4000K
---------------	---------------------	---------------------

**Colour Finish**

				
<b>/AC-01/9mm</b> Sounds Like Light Pendants 9mm Sandstone	<b>/AC-03/9mm</b> Sounds Like Light Pendants 9mm Beige	<b>/AC-04/9mm</b> Sounds Like Light Pendants 9mm Camel	<b>/AC-07/9mm</b> Sounds Like Light Pendants 9mm Clay	<b>/AC-14/9mm</b> Sounds Like Light Pendants 9mm Red
				
<b>/AC-20/9mm</b> Sounds Like Light Pendants 9mm Sky Blue	<b>/AC-23/9mm</b> Sounds Like Light Pendants 9mm Dark Blue	<b>/AC-31/9mm</b> Sounds Like Light Pendants 9mm Anthracite	<b>/AC-32/9mm</b> Sounds Like Light Pendants 9mm Black	<b>/AC-44/9mm</b> Sounds Like Light Pendants 9mm Light Grey

**Code Example** R649204/4K/AC-44/9mm- Sounds Like Light Ensemble Pendant in 4000K in 9mm light grey.

# Sounds Like Light Harmony Pendant

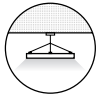



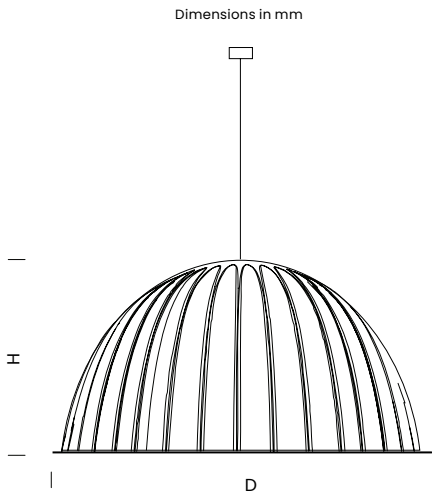





Designed for both aesthetics and functionality, the Harmony Acoustic Pendant Light features a ribbed felt shade that enhances acoustics while exuding modern elegance. Its soft texture complements contemporary interiors, making it ideal for offices, restaurants, and open spaces. Elevate your lighting while reducing noise with this stylish acoustic solution.



Lamp	E27
Material	Polyester - PET
IP Rating	IP20
NRC	0.85

Models	<b>/550</b>	<b>/770</b>
	D: 550mm H: 300mm	D: 770mm H: 400mm

**Colour Finish**

				
<b>/AC-01/5mm</b> Sounds Like Light Pendants 5mm Red	<b>/AC-10/5mm</b> Sounds Like Light Pendants 5mm Khaki	<b>/AC-14/5mm</b> Sounds Like Light Pendants 5mm Gold	<b>/AC-16/5mm</b> Sounds Like Light Pendants 5mm Dark Blue	<b>/AC-22/5mm</b> Sounds Like Light Pendants 5mm Moss Green
				
<b>/AC-31/5mm</b> Sounds Like Light Pendants 5mm Black	<b>/AC-34/5mm</b> Sounds Like Light Pendants 5mm Anthracite	<b>/AC-35/5mm</b> Sounds Like Light Pendants 5mm Light Grey		

**Code Example** R649202/550/AC-35/5mm- Sounds Like Light 550mm Harmony Pendant in 5mm light grey.

# Sounds Like Light Quaver Pendant

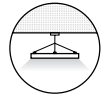

Quaver is a linear, suspended acoustic light fixture designed to accommodate four 15 degree beam angle downlights. The body is an elongated oval thick acoustic panel, serving as both a sleek lighting solution and an effective surface for sound absorption.



Dimensions in mm

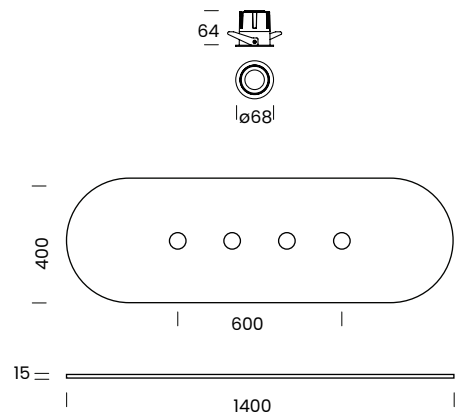











Efficacy	99 Lm/W (per downlight)
CRI	>90 Ra
NRC	0.91
Beam Angle	15° (Standard)
Operating Hours	50,000
SDCM	≤3
IP Rating	IP20

**Beam Angle**

- Standard**  
15° Beam Angle
- /38D**  
38° Beam Angle
- /55D**  
55° Beam Angle

**Colour Finish**

				
<b>/AC-01/9mm</b> Sounds Like Light Pendants 9mm Sandstone	<b>/AC-03/9mm</b> Sounds Like Light Pendants 9mm Beige	<b>/AC-04/9mm</b> Sounds Like Light Pendants 9mm Camel	<b>/AC-07/9mm</b> Sounds Like Light Pendants 9mm Clay	<b>/AC-14/9mm</b> Sounds Like Light Pendants 9mm Red
				
<b>/AC-20/9mm</b> Sounds Like Light Pendants 9mm Sky Blue	<b>/AC-23/9mm</b> Sounds Like Light Pendants 9mm Dark Blue	<b>/AC-31/9mm</b> Sounds Like Light Pendants 9mm Anthracite	<b>/AC-32/9mm</b> Sounds Like Light Pendants 9mm Black	<b>/AC-44/9mm</b> Sounds Like Light Pendants 9mm Light Grey

**Code Example** R649217/AC-44/9mm- Sounds Like Light Quaver Pendant in 3000K, 15 Degree Beam Angle in 9mm light grey.

# Sounds Like Light Breve Pendant

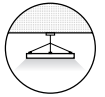

Breve is an elongated rounded rectangle acoustic pendant light, with a clean and easy finish. This provides a soft, organic alternative to more rigid rectangular designs, while still offering a broad, uniform distribution of light and sound absorption. The light source is a linear light with Samsung LED chips, known for longevity and high performance.

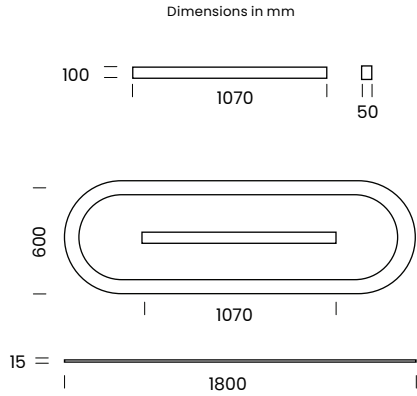

5 YR WARRANTY

Efficacy	120 Lm/W
CRI	>90 Ra
NRC	0.91
Beam Angle	100°
Operating Hours	50,000
SDCM	≤4
IP Rating	IP20

Kelvin	<b>/3K</b>	<b>/4K</b>
	3000K	4000K

**Colour Finish**

<b>/AC-01/9mm</b> Sounds Like Light Pendants 9mm Sandstone	<b>/AC-03/9mm</b> Sounds Like Light Pendants 9mm Beige	<b>/AC-04/9mm</b> Sounds Like Light Pendants 9mm Camel	<b>/AC-07/9mm</b> Sounds Like Light Pendants 9mm Clay	<b>/AC-14/9mm</b> Sounds Like Light Pendants 9mm Red
<b>/AC-20/9mm</b> Sounds Like Light Pendants 9mm Sky Blue	<b>/AC-23/9mm</b> Sounds Like Light Pendants 9mm Dark Blue	<b>/AC-31/9mm</b> Sounds Like Light Pendants 9mm Anthracite	<b>/AC-32/9mm</b> Sounds Like Light Pendants 9mm Black	<b>/AC-44/9mm</b> Sounds Like Light Pendants 9mm Light Grey

**Code Example** R649218/4K/AC-35/9mm- Sounds Like Light Breve Pendant in 9mm Anthracite in 4000K.

# Sounds Like Light Crotchet Pendant

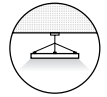



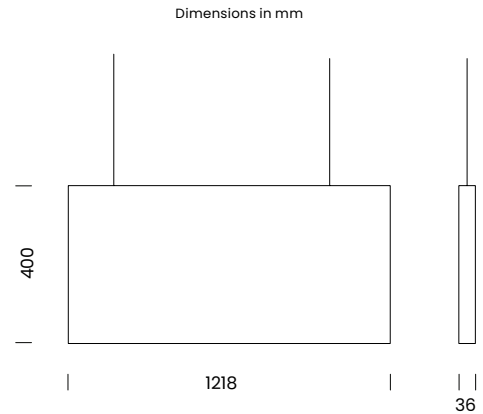







Crochet is a Slim acoustic light baffle with a linear LED with a round aperture optic. With a colour temperature of 4000K, this is the perfect pendant light to include in your office space.



Wattage	30W
Efficacy	100 Lm/W (per downlight)
CRI	>90 Ra
NRC	0.91
Beam Angle	36°
Kelvin	4000K
Operating Hours	50,000
SDCM	≤6
IP Rating	IP20

**Colour Finish**

				
<b>/AC-01/9mm</b> Sounds Like Light Pendants 9mm Sandstone	<b>/AC-03/9mm</b> Sounds Like Light Pendants 9mm Beige	<b>/AC-04/9mm</b> Sounds Like Light Pendants 9mm Camel	<b>/AC-07/9mm</b> Sounds Like Light Pendants 9mm Clay	<b>/AC-14/9mm</b> Sounds Like Light Pendants 9mm Red
				
<b>/AC-20/9mm</b> Sounds Like Light Pendants 9mm Sky Blue	<b>/AC-23/9mm</b> Sounds Like Light Pendants 9mm Dark Blue	<b>/AC-31/9mm</b> Sounds Like Light Pendants 9mm Anthracite	<b>/AC-32/9mm</b> Sounds Like Light Pendants 9mm Black	<b>/AC-44/9mm</b> Sounds Like Light Pendants 9mm Light Grey

**Code Example** R649219/AC-44/9mm- Sounds Like Light Crotchet Pendant in 9mm light grey.

# Sounds Like Light Sonar Pendant

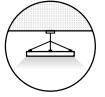

Effortlessly blending acoustic performance with contemporary style, Sonar is a linear pendant light designed to enhance both ambience and clarity. Wrapped in high performance acoustic felt and metal case, its form is soft yet structured, a folded silhouette that absorbs ambient noise while casting an efficient light.

Dimensions in mm

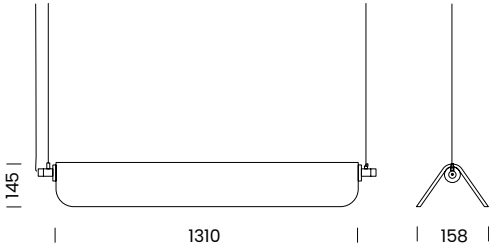

5 YR WARRANTY

Wattage	30W
Efficacy	45 Lm/W
CRI	>90 Ra
NRC	0.91
Beam Angle	75°
Kelvin	4000K
Operating Hours	50,000
SDCM	≤6
IP Rating	IP20

Colour Finish



- /AC-01/9mm**  
Sounds Like Light Pendants 9mm  
Sandstone
- /AC-03/9mm**  
Sounds Like Light Pendants 9mm  
Beige
- /AC-04/9mm**  
Sounds Like Light Pendants 9mm  
Camel
- /AC-07/9mm**  
Sounds Like Light Pendants 9mm  
Clay
- /AC-14/9mm**  
Sounds Like Light Pendants 9mm  
Red



- /AC-20/9mm**  
Sounds Like Light Pendants 9mm  
Sky Blue
- /AC-23/9mm**  
Sounds Like Light Pendants 9mm  
Dark Blue
- /AC-31/9mm**  
Sounds Like Light Pendants 9mm  
Anthracite
- /AC-32/9mm**  
Sounds Like Light Pendants 9mm  
Black
- /AC-44/9mm**  
Sounds Like Light Pendants 9mm  
Light Grey

**Code Example** R649220/AC-35/9mm- Sounds Like Light Sonar Pendant in 9mm Anthracite.

R820302

# Galaxia Up Ring

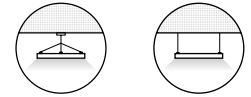

Galaxia is a large LED ring pendant light in black finish. With a direct and indirect light output in a modern circular design, 800mm diameter and opal polycarbonate diffuser, the luminaire guarantees no light leakage, and a softer and uniform light output. The aluminium housing provides an excellent thermal management, making Galaxia ideal for a number of different applications.



Dimensions in mm

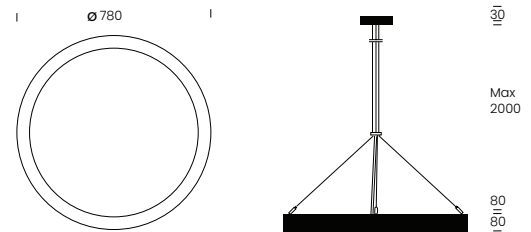

Efficacy	95 Lm/W
CRI	>90 Ra
Beam Angle	105°
Operating Hours	50,000
SDCM	≤3
IP Rating	IP20

Wattage	/35W		/70W	
	Indirect	10W	Indirect	21W
Direct	25W	Direct	49W	

Kelvin	/3K	/4K
	3000K	4000K

Options	/DD	/DL	/E
	DALI dimming	0-10V Dimming	Emergency

**Code Example** R820302/4K/35W - Galaxia 25W Direct 10W Indirect 4000K

R820401

# Galaxia Triangulum

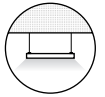
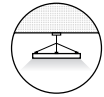

Galaxia is a large LED triangular pendant light in black finish. A modern design with an opal polycarbonate diffuser, the luminaire guarantees no light leakage, with a soft and uniform light output. The aluminium housing provides an excellent thermal management, making Galaxia ideal for a number of different applications.

Dimensions in mm

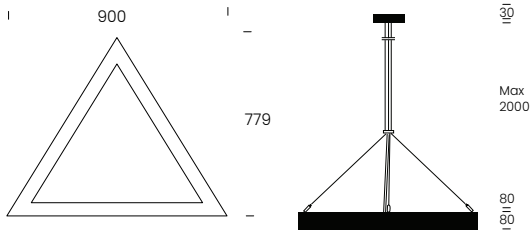

Efficacy	119 Lm/W
CRI	>90 Ra
Beam Angle	105°
Operating Hours	50,000
SDCM	≤3
IP Rating	IP20



<b>Wattage</b>	<b>/20W</b>	<b>/40W</b>
	20W	40W

<b>Kelvin</b>	<b>Standard</b>
	3000K / 4000K Switchable colour temperature

<b>Options</b>	<b>/DD</b>	<b>/DL</b>	<b>/E</b>
	DALI dimming	0-10V Dimming	Emergency

**Code Example** R096950/3K/70W - Modus Max 70W 3000K

R820302

# Galaxia Hexagonal

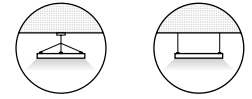

Galaxia is a large LED ring pendant light in black finish. In a modern hexagonal design, an opal polycarbonate diffuser, the luminaire guarantees no light leakage, and a softer and uniform light output. The aluminium housing provides an excellent thermal management, making Galaxia ideal for a number of different applications.



Dimensions in mm

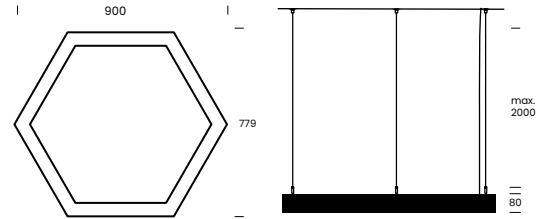

Efficacy	112 Lm/W
CRI	>90 Ra
Beam Angle	105°
Operating Hours	50,000
SDCM	≤3
IP Rating	IP20

**Wattage**      **/30W**      **/60W**  
 30W                      60W

**Kelvin**              **Standard**  
 3000K / 4000K  
 Switchable colour  
 temperature

**Options**            **/DD**            **/DL**            **/E**  
 DALI                      0-10V Dimming      Emergency  
 dimming

**Code Example**      R820601/30W - Galaxia 25W Direct 10W Indirect 4000K

R101801

# Nebula



Nebula is a suspended panel light with a unique design offering a 360 degree beam lighting effect. The 60W suspended office light delivers up to 6482 lumens spreading in all directions, is available in 3000K or 4000K and comes with a magnetic box for ease of installation.

Dimensions in mm

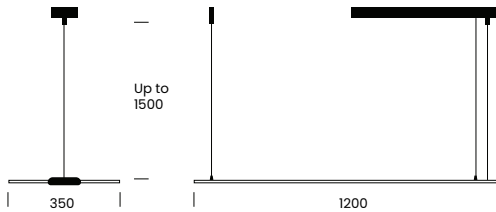

Efficacy	108 Lm/W
CRI	>80 Ra
Beam Angle	360°
Operating Hours	50,000
SDCM	≤6
IP Rating	IP20

**Wattage**      **/60W**  
60W

**Kelvin**      **/3K**      **/4K**  
3000K      4000K

**Options**      **/DD**      **/E**      **/DDPRO**  
DALI dimming      Emergency (non IP rated)      DALI Addressable Emergency

**Code Example**      R101801/ 60W/4K - Nebula 60W 4000K



# Sounds Like Light biophilic lighting.

R920\_



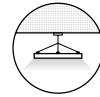

FloraLume brings the serenity of nature indoors with its stunning range of biophilic pendant lights. Handcrafted in Brighton, UK, these lights feature vibrant moss and flower art encased in elegantly designed pendants. Ideal for enhancing any space with a touch of green, these lights promote a peaceful and productive environment.

CRI	>90 Ra
Operating Hours	50,000
SDCM	≤3
Power Supply	Internal Driver
IP Rating	IP20



#### Natural Moss

We use preserved moss, maintaining its texture without chemicals. Using only a salt water solution and food grade dye, the moss is 'frozen in time'.



#### Eco Friendly

All materials are sustainably sourced and contribute to reduced carbon emissions.



#### Low Maintenance

Designed for longevity with minimal maintenance needs. No water, soil, or direct sunlight required.



#### Air Quality

Naturally purifies the air, enhancing your living or workspace.



#### Sound Absorbing

Helps reduce noise levels, making it ideal for busy or open-plan environments.



#### Allergen Free

Safe for individuals with allergies, contributing to a healthier indoor climate.



#### Custom Layouts

Tailor your moss art to fit the unique style of your space.

Shapes



**302**

FloraLume Round

Wattage **70W (49W+21W)**

Lumens **4658 +1996**

Beam Angle **105°**

Kelvin **/3K**      **/4K**  
 3000K      4000K

Dimensions in mm

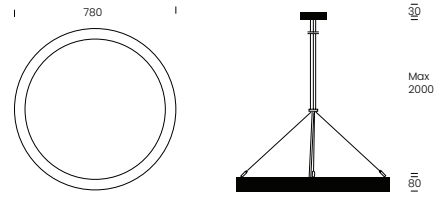

**401**

FloraLume Triangulum

Wattage **40W**

Lumens **4621**

Beam Angle **105°**

Kelvin **Standard**  
 3000K / 4000K  
 Switchable colour  
 temperature

Dimensions in mm

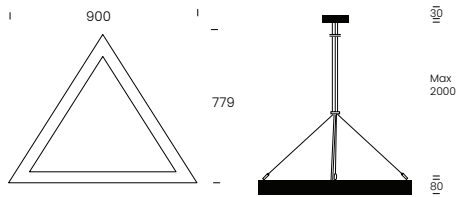

**601**

FloraLume Hexagonal

Wattage **60W**

Lumens **6532**

Beam Angle **105°**

Kelvin **Standard**  
 3000K / 4000K  
 Switchable colour  
 temperature

Dimensions in mm

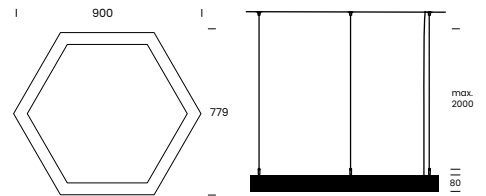

Design



**/MOSS**  
 Moss finish



**/FLOMOSS**  
 Flower moss finish



**/FUNMOSS**  
 Fungi moss finish

Code Example R920601/60W/Moss - FloraLume Hexagonal 60W Switchable 3000K-4000K with moss finish

# Moon circular feature light.

R920\_---





## Moon circular feature light

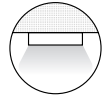
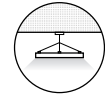

Moon is a bold **direct/indirect** feature light that can be surface mounted or used as a pendant.

It is available in two sizes: the powerful 875mm diameter Supermoon and its baby brother Minimoon at 585mm diameter. Moon boasts a **switchable colour temperature** where the installer can select 3000K, 4000K or 5000K light which is delivered via a microprismatic glare control diffuser.

Efficacy	110 Lm/W
CRI	>90 Ra
Beam Angle	120°
Operating Hours	50,000
SDCM	≤3
L70 B50	100,000 hours
IP Rating	IP20

**Models**



**5 YR**  
WARRANTY

**01**  
MiniMoon

**Wattage**     **/38W**  
38W

**/48W**  
48W

Dimensions in mm

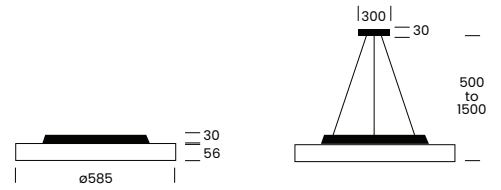

**02**  
SuperMoon

**Wattage**     **/76W**  
76W

**/96W**  
96W

Dimensions in mm

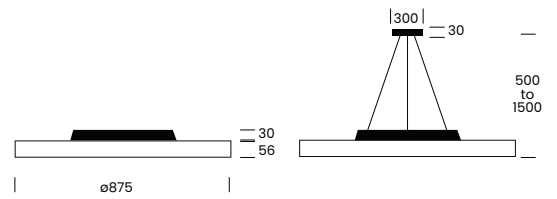

**Kelvin**

**01**

3000K

**02**

4000K

**03**

5000K

**Options**

**/DH**

Mains dimming

**/DD**

DALI dimming

**/DL**

0-10V dimming

**/DSI**

DSI dimming

**/E**

Integrated  
Emergency

**Accessories**



**R8202-SPD**  
Suspended  
mounting kit

**Code Example**     R820103/38W/E - Minimoon 38W in 5000K Emergency

R096201

# Pulsar pendant



Pulsar is a modern pendant combining efficacy with elegance. With a minimalistic, contemporary design and durable aluminium construction it can add a touch of subtle stylish architectural lighting in domestic or commercial spaces. The same style luminaire is also available in surface mounted, recessed and track mounted version.

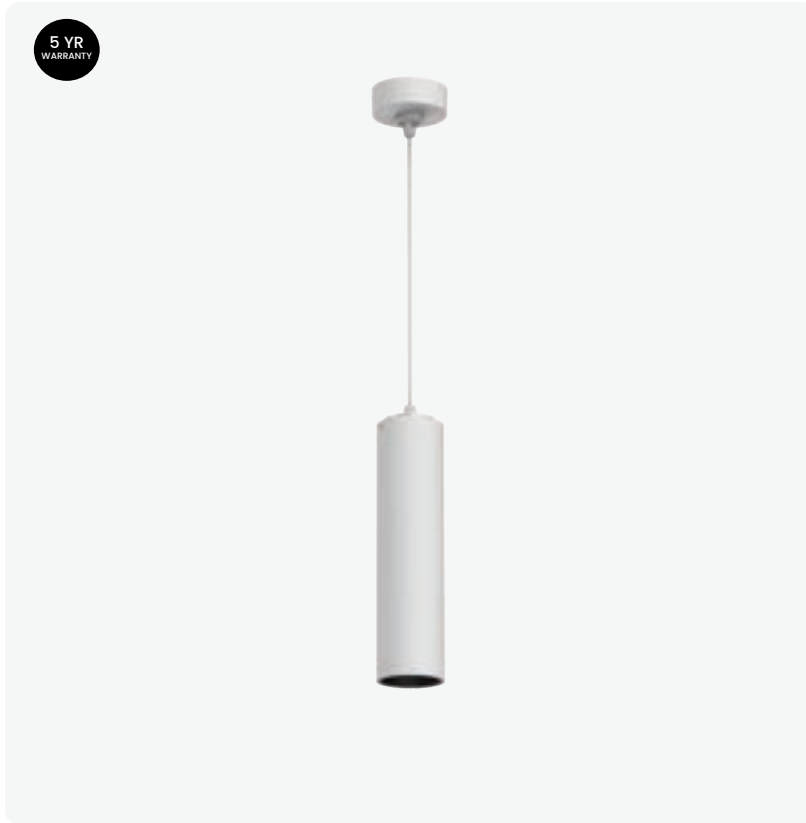

5 YR WARRANTY

Dimensions in mm

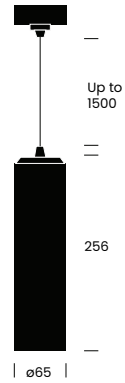

Wattage	10W
Efficacy	90 Lm/W
CRI	>90 Ra
Beam Angle	38° Standard
Operating Hours	50,000
SDCM	≤3
L70 B50	100,000 hours
IP Rating	IP20

**Kelvin**      **/3K**      **Standard**  
 3000K                      4000K

**Colour**

**/BK**      **/WT**  
 Black finish      White finish

**Beam angle**      **/15**      **/24**      **Standard**      **/55**  
 15 degree beam angle      24 degree beam angle      38 degree beam angle      55 degree beam angle

**Code Example**      R096201/3K/BK - Pulsar pendant 10W, 38° beam angle in 3000K in black.



**The Oche Club**, darts bar in Jersey.  
Product: Pulsar Pendant







# The Freedom Centre, cinema building in Jersey.

RICOMAN proudly completed a dynamic lighting project for a new church in the heart of St. Helier, Jersey, repurposing an old Odeon cinema. The brief required a flexible lighting scheme with dimmable lines of light, both recessed and suspended in the varied ceiling heights. Our design team rose to the challenge, creating a clever solution for the curved lower ceiling by incorporating customisable **Endor downlights** with Titanium reflectors, perfectly complementing the dark grey/black finish.

Thanks to our technical team, the project seamlessly navigated around the structural steel beams, ensuring optimal results.





**The Freedom Centre** in Jersey  
Client: LED Lighting Jersey & Photos: LED Lighting Jersey





# Downlights

# Neptune low-glare IP65 downlight

Neptune is an ideal low-glare IP65 downlight for a PL replacement available with a range of magnetic reflector options which are available in polished chrome, white, matte silver or titanium finish. Neptune comes in four cutout sizes and a range of wattages from 8W to 32W.



Dimensions in mm

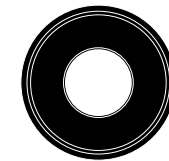
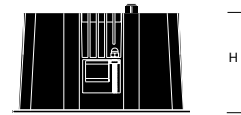

Efficacy	106Lm/W
CRI	>90 Ra
Beam Angle	55°
Operating Hours	50,000
SDCM	≤3
L70 B50	100,000 hours
IP Rating	IP65

Model	10	15	17	20
Size	ø110 x H62	Size ø165 x H90	Size ø180 x H100	Size ø218 x H113
Cut out	100	Cut out 150	Cut out 170	Cut out 200

Wattage	/8W	/16W	/12W	/22W	/13W	/26W	/16W	/32W
	100mm cut out model	100mm cut out model	150mm cut out model	150mm cut out model	170mm cut out model	170mm cut out model	200mm cut out model	200mm cut out model

## Reflectors

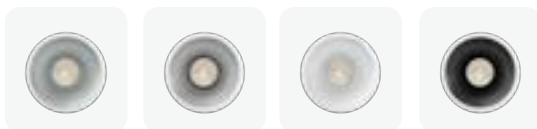

**/MS**

Matte silver

**/PC**

Polished chrome

**/WT**

White

**/TI**

Titanium

## Kelvin

**/3K**

3000K

**/4K**

4000K

**Code Example** R093110/3K/8W/100MS - Neptune 100mm Downlight with Matte Silver Reflector 8W 3000K

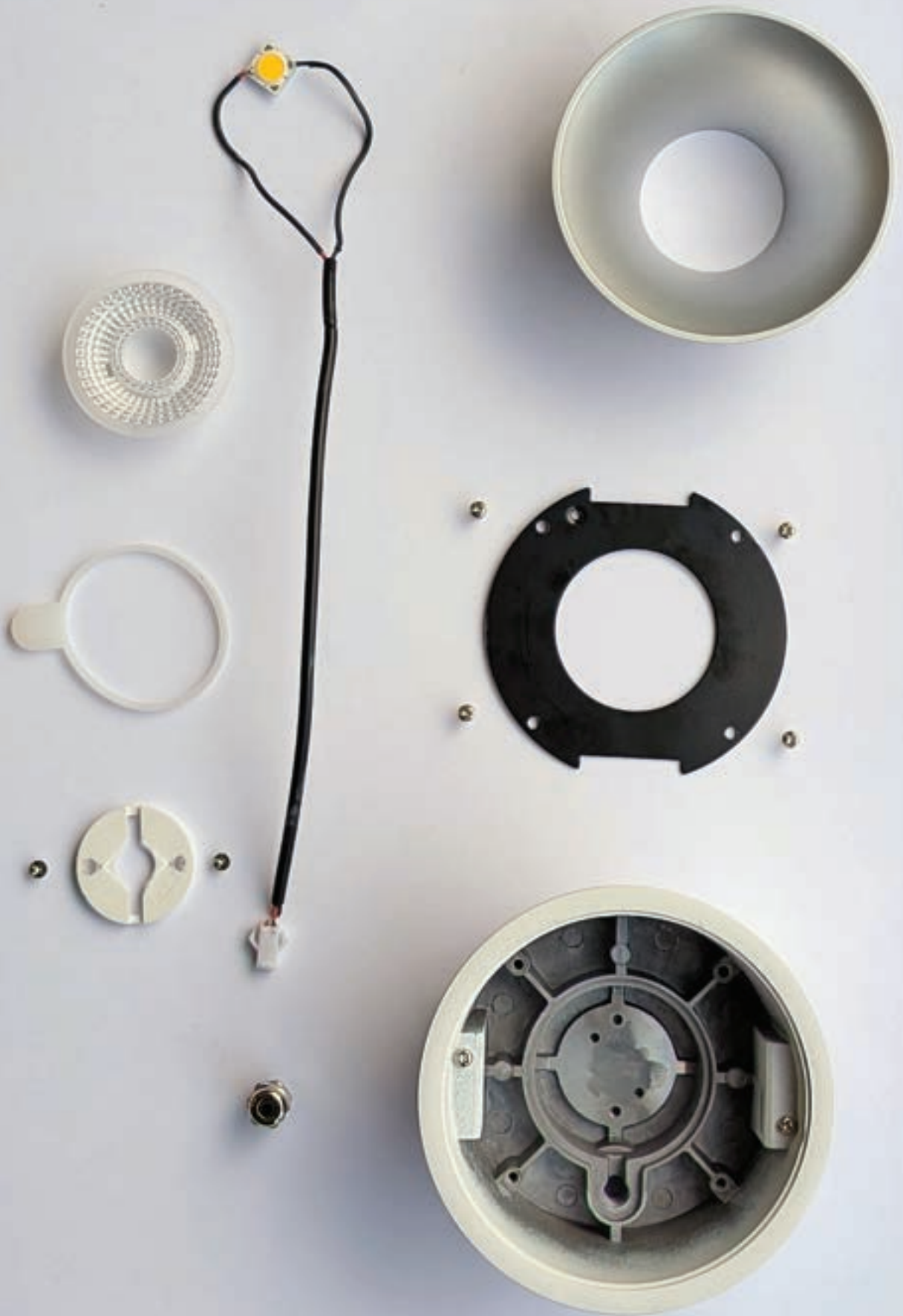



# E-Pro architectural downlights.



# E-Pro architectural downlights



Efficacy	106 lm/W
CRI	90 Ra
Beam Angle	50°
Operating Hours	50,000
SDCM	≤3
L70 B50	100,000 hours
IP Rating	IP20



E-Pro is a range of linear or square cellular downlights available in a variety of cell configurations & mounting options.

The family features revolutionary optics combined to deliver an extremely **low glare** rating and architectural styling.

#### Mounting options

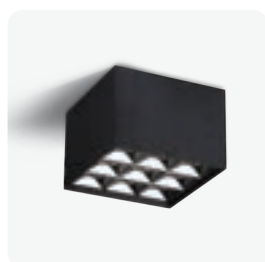

**36**  
Surface mounted



**37**  
Recessed

#### Colour



**/BK**  
Black finish



**/WT**  
White finish

# E-Pro architectural downlights



**Cell options**



**01**

Model	Single cell
Recessed size	54x54x47
Cut Out	50x50
Surface size	49x49x83



**03**

Model	1x3 cells
Recessed size	130x54x47
Cut Out	125x50



**05**

Model	1x5 cells
Recessed size	206x54x47
Cut Out	200x50



**10**

Model	1x10 cells
Recessed size	396x54x47
Cut Out	390x50



**22**

Model	2x2 cells
Recessed size	93x93x47
Cut Out	88x88
Surface size	86x86x88



**33**

Model	3x3 cells
Recessed size	131x131x47
Cut Out	125x125
Surface size	125x125x88

**Wattage**

For 1x1 cell	For 1x3 cell	For 1x5 cell	For 1x10 cell	For 2X2 cell	For 3X3 cell
<b>/5W</b>	<b>/6W</b>	<b>/10W</b>	<b>/20W</b>	<b>/8W</b>	<b>/18W</b>
	<b>/12W</b>	<b>/20W</b>	<b>/40W</b>	<b>/16W</b>	<b>/36W</b>

**Kelvin**

<b>/27K</b> 2700K	<b>/3K</b> 3000K	<b>/4K</b> 4000K
----------------------	---------------------	---------------------

**Options**

<b>/DH</b> Mains dimming	<b>/DD</b> DALI dimming	<b>/DL</b> 0-10V dimming	<b>/DSI</b> DSI dimming
-----------------------------	----------------------------	-----------------------------	----------------------------

**Code Example** R093722/8W/BK/3K - E-Pro Recessed 2x2 cells 8W in black in 3000K

R098900

# Core IP65 fire rated with switchable kelvin

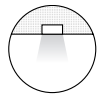

Core is a 30/60/90 min fire rated downlight, tested with I-joint ceilings. It is switchable 3000K or 4000K via a dip switch at the front (behind bezel) and has an IP65 front. Core comes with an integrated dimmable driver and interchangeable bezels as optional.



Dimensions in mm

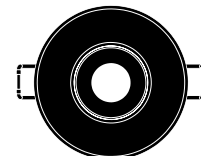
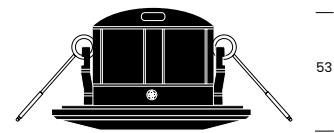

ø84

Wattage	6W
Lumens	602
Kelvin	3000K-4000K Switchable
CRI	>90 Ra
Beam Angle	60°
Operating Hours	50,000
SDCM	≤6
L70 B50	50,000 hours
IP Rating	IP65

## Bezel options



**R098-01**  
Core Chrome Bezel



**R098-12**  
Core Metal Brushed Chrome Bezel



**R098-03**  
Core Black Bezel

## Accessories

<b>R098-01</b>	Core chrome bezel
<b>R098-03</b>	Core black bezel
<b>R098-12</b>	Core metal brushed chrome bezel

**Code Example** R098900 - Core 6W 3000K | 4000K switchable Mains Dim with white bezel

R095601

# R3 tunable white-dimmable-IP65-fire rated

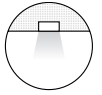

The epitome of a fire rated IP65 all-in one downlight. R3 comes in tunable or fixed colour temperature. A wall switch can be used to change colour temperature and dim to night mode. A remote control can smoothly dim and change from 3000K through to 5000K. R3 offers a variety of four different bezels to suit a range of different installations.

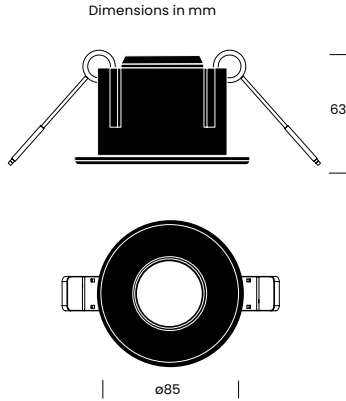

Wattage	6W
Lumens	591
Kelvin	Tunable from 3000K to 5000K
CRI	>90 Ra
Beam Angle	60°
Operating Hours	50,000
SDCM	≤6
L70 B50	50,000 hours
IP Rating	IP65



RICOMAN LIGHTING CATALOGUE EDITION 8

<b>Kelvin</b>	<b>/TW</b> Tunable white 3000K-5000K	<b>/3K</b> 3000K	<b>/4K</b> 4000K
---------------	--	---------------------	---------------------

<b>Options</b>	<b>/DD</b> DALI dimming	<b>/DL</b> 0-10V dimming	<b>/DSI</b> DSI Dimming
----------------	-------------------------------	--------------------------------	----------------------------

**Bezel options**



<b>Standard</b> White bezel	<b>R095-01</b> R3 chrome bezel	<b>R095-02</b> R3 metal brushed chrome bezel	<b>R095-03</b> R3 black bezel
--------------------------------	-----------------------------------	--	----------------------------------

**Code Example** R095601/TW- R3 6W Tunable White 3000K-5000K Control Dim

**Accessories**

<b>R095-01</b>	R3 chrome bezel
<b>R095-02</b>	R3 brushed chrome bezel
<b>R095-03</b>	R3 black bezel
<b>R09-882</b>	Remote control for r3/centorio

# Pinnacle spot



Pinnacle is a fixed mini spot light ideal for prestigious applications. The standard 15° or the optional 38° / 55° degree beam angles serve to achieve the desired spot lighting effect. The opal diffuser guarantees a smooth light distribution with low UGR and the titanium reflector adds a discrete contemporary decorative touch.

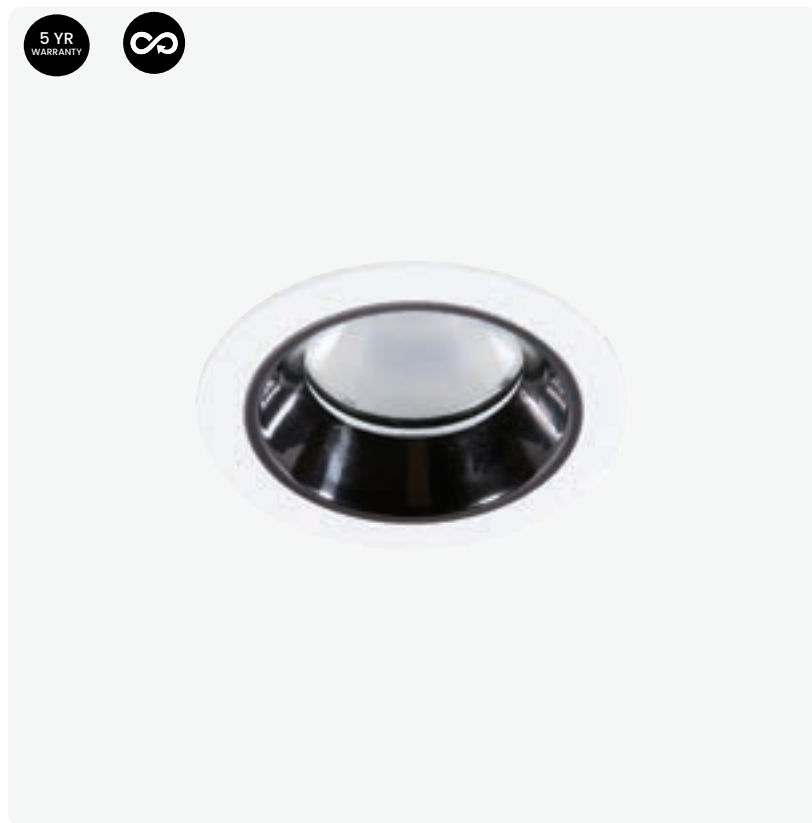

Dimensions in mm

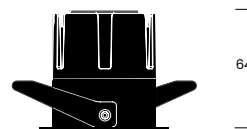

ø84

Wattage	6W
Efficacy	100 Lm/W
Kelvin	3000K
CRI	>90 Ra
Beam Angle	15° Standard
Operating Hours	50,000
SDCM	≤3
L70 B50	100,000 hours
IP Rating	IP20

<b>Beam angles</b>	<b>standard</b>	<b>/38D</b>	<b>/55D</b>
	15 degree angle	38 degree angle	55 degree angle

<b>Kelvin</b>	<b>standard</b>	<b>/27K</b>
	3000K	2700K

<b>Options</b>	<b>/DH</b>	<b>/DD</b>	<b>/DL</b>	<b>/DSI</b>
	Mains dimming	DALI dimming	0-10V dimming	DSI dimming

**Accessories**



**R09-HC40**  
Honeycomb Diffuser

**Code Example** R097701/55D- Pinnacle 6W 3000K 55° beam



# Endor customisable downlights.



The concept behind Endor was to enable you to create **diverse lighting environments using one luminaire range**, for a consistent style throughout. Endor allows designers to work with different lighting applications, light outputs, beam angles, housings, reflectors and finishes, using unobtrusive and low glare fixtures.

R0966\_----- **Endor** customisable downlights



Efficacy	100 Lm/W
CRI	90 Ra
Operating Hours	50,000
SDCM	≤3
L70 B50	100,000 hours
IP Rating	IP20 / IP65



The Endor collection features a wide range of recessed lighting fixtures, combining a discreet presence with high performance. You can choose your housing from square, round or trimless round.

Beam angles options are 15°, 38° or 55°. Downlight or wallwash reflectors are available in Titanium, Polished Chrome or Matte Silver finishes.

**Wattage**



<b>A1</b>		<b>A2</b>		<b>A3</b>		<b>A4</b>	
Wattage	12W	Wattage	24W	Wattage	32W	Wattage	42W
Total depth	112mm	Total depth	140mm	Total depth	169mm	Total depth	184mm

**Beam angle**

For 12W		For 24W		For 32W		For 42W	
<b>B1</b>	15°	<b>B3</b>	15°	<b>B6</b>	15°	<b>B9</b>	15°
<b>B2</b>	38°	<b>B4</b>	38°	<b>B7</b>	38°	<b>B10</b>	38°
<b>B3</b>	55°	<b>B5</b>	55°	<b>B8</b>	55°	<b>B12</b>	55°

Endor is designed for the **circular economy**, with a long lifespan, modular design, and recyclable aluminium. Its durable components, including LED modules and Tridonic drivers, ensure over 50,000 hours of use. Replaceable parts extend its life, reducing waste and supporting sustainability.

**Housing**



Round			Round Rimless			Square			IP65 round			IP65 square		
Code	Wattage	Cut-out	Code	Wattage	Cut-out	Code	Wattage	Cut-out	Code	Wattage	Cut-out	Code	Wattage	Cut-out
<b>C1</b>	12W	ø75	<b>C2</b>	12W	ø75	<b>C3</b>	12W	75x75	<b>C4</b>	12W	ø75	<b>C5</b>	12W	75x75
<b>C6</b>	24W	ø100	<b>C7</b>	24W	ø100	<b>C8</b>	24W	100x100						
<b>C9</b>	32W	ø125	<b>C10</b>	32W	ø122	<b>C11</b>	32W	125x125						
<b>C12</b>	42W	ø150	<b>C13</b>	42W	ø148	<b>C14</b>	42W	150x150						

**Reflector**

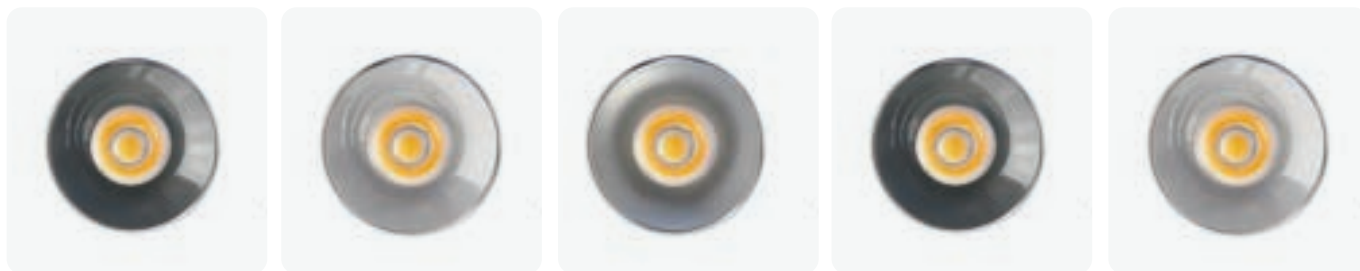

Round Titanium

<b>E1</b>	12W
<b>E4</b>	24W
<b>E7</b>	32W
<b>E10</b>	42W

Round Polished Chrome

<b>E2</b>	12W
<b>E5</b>	24W
<b>E8</b>	32W
<b>E11</b>	42W

Round Matte Silver

<b>E3</b>	12W
<b>E6</b>	24W
<b>E9</b>	32W
<b>E12</b>	42W

Wallwash Titanium

<b>D1</b>	12W
<b>D4</b>	24W
<b>D7</b>	32W
<b>D10</b>	42W

Wallwash Chrome

<b>D2</b>	12W
<b>D5</b>	24W
<b>D8</b>	32W
<b>D11</b>	42W

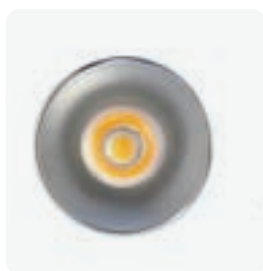

Wallwash Matte Silver

<b>D3</b>	12W
<b>D6</b>	24W
<b>D9</b>	32W
<b>D12</b>	42W

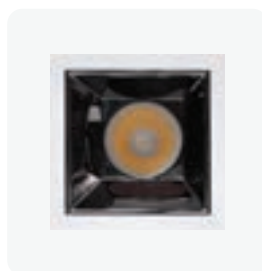

Square Titanium

<b>F1</b>	12W
<b>F4</b>	24W
<b>F7</b>	32W
<b>F10</b>	42W

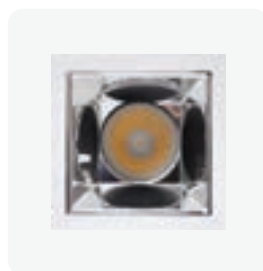

Square Chrome

<b>F2</b>	12W
<b>F5</b>	24W
<b>F8</b>	32W
<b>F11</b>	42W

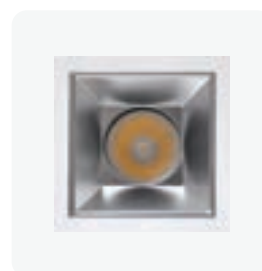

Square Matte Silver

<b>F3</b>	12W
<b>F6</b>	24W
<b>F9</b>	32W
<b>F12</b>	42W

**Kelvin**

<b>/27K</b> 2700K	<b>/3K</b> 3000K	<b>/4K</b> 4000K
----------------------	---------------------	---------------------

**Options**

<b>/DH</b> Mains dimming	<b>/DD</b> DALI dimming	<b>/DL</b> 0-10V dimming	<b>/DSI</b> DSI Dimming
-----------------------------	----------------------------	-----------------------------	----------------------------

**Code Example** R0966A4B10C12D10/3K - Endor 42W 15° Round Wallwasher - Titanium Reflector in 3000K

R093401

# Sirius high output downlight



Sirius is a recessed high output downlight with a 210mm cut out, ideal for commercial applications. Available in standard or high output, delivers up to 4418 lumens with an excellent CRI >90 Ra. Sirius comes in 3000K or 4000K and white or black finish. Emergency and dimming versions come as options to further increase flexibility.



Dimensions in mm

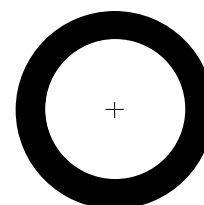
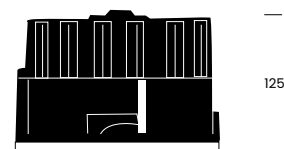

ø230

Efficacy	105 Lm/W
CRI	>90 Ra
Beam Angle	60°
Operating Hours	50,000
SDCM	≤3
L70 B50	100,000 hours
IP Rating	IP20

**Colour**



**/WT**  
White bezel



**/BK**  
Black bezel

**Kelvin**

**/3K**  
3000K

**/4K**  
4000K

**Wattage**

**/24W**  
24W

**/42W**  
42W

**Options**

**/DH**  
Mains dimming

**/DD**  
DALI dimming

**/DL**  
0-10V dimming

**/DSI**  
DSI dimming

**Code Example** R093401/BK/3K/24W - Sirius with black bezel in 24W 3000K

R09\_-----

# Ultra-Slim R round slim downlight

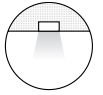

Ideal for low ceiling voids and perfect for achieving a clean finish in any environment, Ultra-Slim is a round downlight that offers a variety of options. Five different cutouts/ wattages featuring a less than 30mm deep profile, four different colour temperatures, dimmable or non dimming standard options, emergency and a TP(a) rated diffuser as an add on, complete the series.

Dimensions in mm

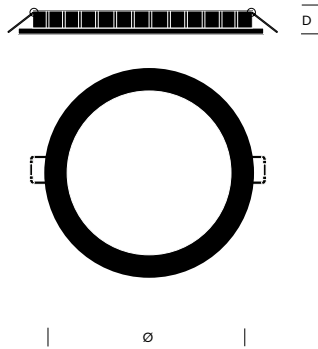

Efficacy	110 Lm/W
CRI	>82 Ra
Beam Angle	90°
Operating Hours	50,000
SDCM	≤4
L70 B50	70,000 hours
IP Rating	IP54

Type	32	15
	Non Dimmable	Mains Dimmable

Size	8W	11W	15W	18W
Size	Ø 110 x 24D	Size Ø 140 x 25D	Size Ø 160 x 26D	Size Ø 180 x 27D
Cut out	95	Cut out 125	Cut out 140	Cut out 160

23W	
Size	Ø230 x 28D
Cut out	200

Kelvin	3000K	4000K

**Accessories**



**R09-23**  
23W ultra-slim cut out extension ring



Carina is a cost and energy efficient PL downlight replacement designed to reduce glare and deliver an excellent thermal control. To suit a variety of applications, it comes in four sizes and two colour temperatures with dimming and emergency options available.

5 YR  
WARRANTY



Dimensions in mm

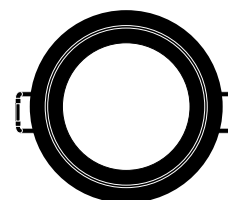
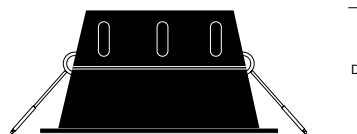

Efficacy	100 Lm/W
CRI	>85 Ra
Beam Angle	60°
Operating Hours	50,000
SDCM	≤4
L70 B50	70,000 hours
IP Rating	IP20

Model	01	02	03	04
Wattage	12W	12W	15W	15W
Kelvin	3000K	4000K	3000K	4000K
Size	Ø 145 x 64D	Ø 145 x 64D	Ø 160 x 74D	Ø 160 x 74D
Cut out	130	130	140	140
Wattage	18W	18W	23W	23W
Kelvin	3000K	4000K	3000K	4000K
Size	Ø 190 x 85	Ø 190 x 85	Ø 230 x 90	Ø 230 x 90
Cut out	165	165	200	200

Options	/DH	/DD	/DL	/DSI
	Mains dimming	DALI dimming	0-10V dimming	DSI dimming

#### Accessories



**R09-23**  
23w ultra-slim cut out extension ring

**Code Example** R093302 - Carina 12W 4000K

R098802

# Centorio all in one downlight

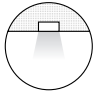

Fire rated dimmable downlight that changes colour temperature from warm to cool white. A wall switch can be used to change colour temperature between 3000K-4000K-5000K and dim down to night mode. A remote control is also available to smoothly dim and change from 3000K through to 5000K. Centorio has an IP65 front and comes with three different bezels as standard.

Dimensions in mm

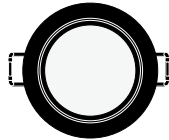
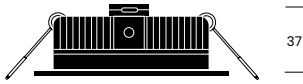

∅110

Wattage	12W
Efficacy	100 Lm/W
Kelvin	Tunable from 3000K to 5000K
CRI	>90 Ra
Beam Angle	60°
Operating Hours	50,000
SDCM	≤6
L70 B50	50,000 hours
IP Rating	IP65



RICOMAN LIGHTING CATALOGUE EDITION 8

**Bezel options**



**Standard**  
White bezel

**Standard**  
Polished chrome bezel

**Standard**  
Satin nickel bezel

**Code Example** R098802 - Centorio 12W Fire Rated tunable white 3000K - 5000K

**Accessories**



**R09-882**  
R3 & Centorio Remote Control Controls up to 100 downlights in 4 rooms/areas

# Protium gimbal downlight



Protium is a recessed gimbal downlight with adjustable light distribution options. It features an integral LED light engine and remote driver for easy installation. The series comes in three sizes and two colour temperatures, with dimmable and emergency options available.



Dimensions in mm

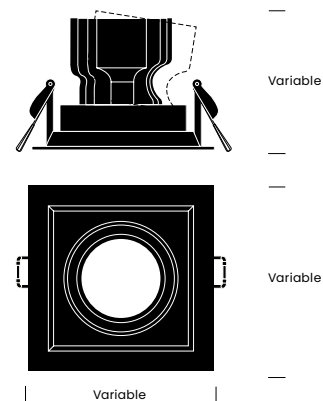

Efficacy	105 Lm/W
CRI	>90 Ra
Beam Angle	40°
Operating Hours	50,000
SDCM	≤3
L70 B50	100,000 hours
IP Rating	IP20

Model	01	02	03
Type	<b>Single head</b>	Type <b>Double head</b>	Type <b>Triple head</b>
Wattage	<b>22W</b>	Wattage <b>44W</b>	Wattage <b>66W</b>
Size	<b>140 x 140</b>	Size <b>270 x 140</b>	Size <b>375 x 140</b>
Cut out	<b>125 x 125</b>	Cut out <b>255 x 125</b>	Cut out <b>360 x 125</b>

Kelvin	<b>/3K</b>	<b>/4K</b>
	3000K	4000K

Options	<b>/DH</b>	<b>/DD</b>	<b>/DL</b>	<b>/DSI</b>
	Mains dimming	DALI dimming	0-10V dimming	DSI dimming

#### Accessories

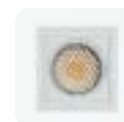

**/R09-HC65**  
Honeycomb diffuser

**Code Example** R093003/3K - Protium 66W in 3000K.

# Protium Max extra large gimbal downlight

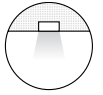

Protium Max is an extra large recessed gimbal downlight with adjustable light distribution options. It features an integral LED light engine and remote driver for easy installation. The series comes in three sizes, two outputs each, and two colour temperatures, with dimmable and emergency options available.

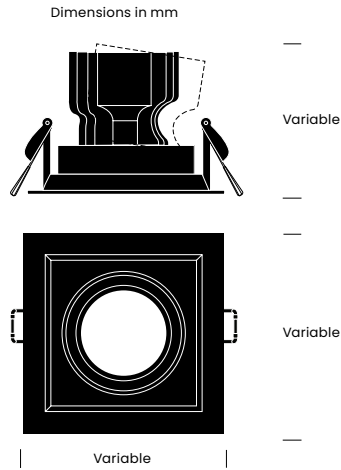

Efficacy	10 Lm/W
CRI	>90 Ra
Beam Angle	40°
Operating Hours	50,000
SDCM	≤3
L70 B50	100,000 hours
IP Rating	IP20

**Model**



**11**

Type	<b>Single head</b>
Size	<b>175 x 175 x D133</b>
Cut out	<b>160 x 160</b>



**12**

Type	<b>Double head</b>
Size	<b>330 x 175 x D133</b>
Cut out	<b>315 x 160</b>



**14**

Type	<b>Triple head</b>
Size	<b>475 x 175 x D133</b>
Cut out	<b>460 x 160</b>

<b>Wattage</b>	<b>/25W</b>	<b>/40W</b>	<b>/50W</b>	<b>/80W</b>	<b>/75K</b>	<b>/120K</b>
	Single head	Single head	Double head	Double head	Triple head	Triple head

<b>Kelvin</b>	<b>/3K</b>	<b>/4K</b>
	3000K	4000K

<b>Options</b>	<b>/DH</b>	<b>/DD</b>	<b>/DL</b>	<b>/DSI</b>
	Mains dimming	DALI dimming	0-10V dimming	DSI dimming

**Code Example** R093011/4K/25W - Protium Max Single 25W 4000K

# Modus surface mounted



Modus is a circular surface mounted or pendant downlight with a white aluminium body and a glass TP(a) rated diffuser. It features high efficacy, IP65 protection, two wattage options and is available in 3000K or 4000K with optional DALI dimming.



Dimensions in mm



Efficacy	110 - Lm/W
CRI	>90 Ra
Beam Angle	60°
Operating Hours	50,000
SDCM	≤3
L70 B50	100,000 hours
IP Rating	IP65

## Colour

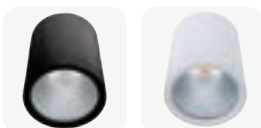

**/BK**

Black body

**/WT**

White body

## Kelvin

**/27K**

2700K

**/3K**

3000K

**/4K**

4000K

## Wattages

**/14W**

14W

**/28W**

28W

## Options

**/DD**

DALI dimming

**/E**

Emergency (non IP rated)

**Code Example** R096920/WT/4K/28W - Modus Surface 28W White Finish 4000K

## Accessories

**R096-20/WT** White modus pendant kit

**R096-20/BK** Black modus pendant kit





Saturn provides multi-directional wallwash/accent lighting with rotation and angle adjustments. Its adjustable head rotation of 340° and tiltable head of -18° to +45° make them perfect for internal sign lighting. The series comes in three sizes and two colour temperatures, with dimmable and emergency options.



5 YR  
WARRANTY

Dimensions in mm

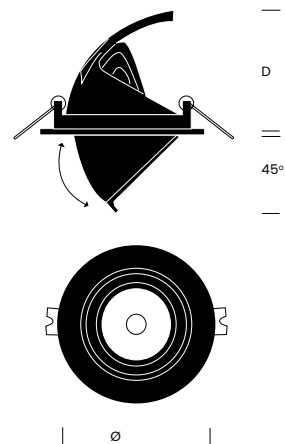

Efficacy	105 Lm/W
CRI	>90 Ra
Beam Angle	40°
Operating Hours	50,000
SDCM	≤3
L70 B50	100,000 hours
IP Rating	IP20

Model	01	02	03	04
Wattage	12W	12W	24W	24W
Kelvin	3000K	5000K	3000K	5000K
Diameter	105	105	158	158
Cut out	90	90	145	145
Depth	82	82	130	130
	<b>05</b>	<b>06</b>		
Wattage	24W	24W		
Kelvin	3000K	5000K		
Diameter	188	188		
Cut out	170	170		
Depth	159	159		

Options	/DH	/DD	/DL	/DSI
	Mains dimming	DALI dimming	0-10V dimming	DSI dimming

**Code Example** R091806/188 - Saturn 40W 5000K

R096950

# Modus Max

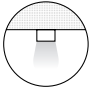

Modus Max is a circular, high output IP65 downlight ideal for large areas. It comes in 70W, 100W or 150W versions with a white aluminium body and a glass TP(a) rated diffuser. Modus Max can be suspended via either a chain or a rod and is available in 3000K or 4000K with optional DALI dimming.

Dimensions in mm

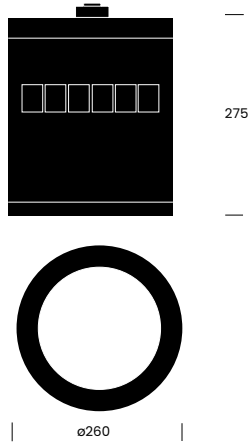

Efficacy	115 Lm/W
CRI	>85 Ra
Beam Angle	57°
Operating Hours	50,000
SDCM	≤3
L70 B50	100,000 hours
IP Rating	IP65

Kelvin	<b>/3K</b>	<b>/4K</b>	
	3000K	4000K	
Wattages	<b>/70W</b>	<b>/100W</b>	<b>/150W</b>
	70W	100W	150W
Options	<b>/DD</b>	<b>/E</b>	<b>/DDPRO</b>
	DALI dimming	Emergency (non IP rated)	DALI Addressable Emergency



RICOMAN LIGHTING CATALOGUE EDITION 8

**Code Example** R096950/3K/70W - Modus Max 70W 3000K

**Accessories**



**R096-50**  
Modus Max suspension rod

# Pulsar Lite spotlight.

R09\_





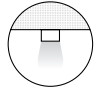

Pulsar Lite is a modern **angle and rotation adjustable** downlight with durable aluminium body. Installation is surface mounted or recessed, with white or black lens finish, four different beam angles and two colour temperatures. The same style luminaire is also available in **pendant, track mounted and integrated in our linear lighting** system for a consistent style throughout.



Efficacy	100 Lm/W
Wattage	12W
CRI	>90 Ra
Beam Angle	24° Standard
Operating Hours	50,000
SDCM	≤3
L70 B50	100,000 hours
IP Rating	IP20

Model



5 YR  
WARRANTY

**64**  
Pulsar Lite recessed mounted

Wattage	12W
Size	ø52 x H192
Cut Out	85

Dimensions in mm

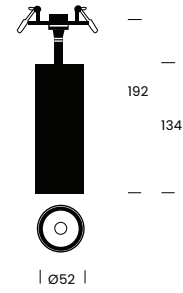

**65**  
Pulsar Lite surface mounted

Wattage	12W
Size	ø52 x H200

Dimensions in mm

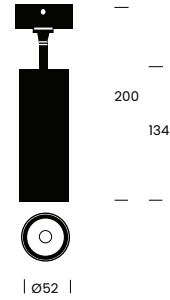

Kelvin	<b>01</b>	<b>02</b>
	3000K	4000K

Colour



**Standard**  
White body

**/BK**  
Black body

Reflector colour



**Standard**  
White reflector

**/BR**  
Black reflector

Beam angle	<b>/15</b>	<b>Standard</b>	<b>/38</b>	<b>/55</b>
	15 degree beam angle	24 degree beam angle	38 degree beam angle	55 degree beam angle

Accessories



**R09-HC40**  
Honeycomb  
diffuser

**Code Example** R096402 - Pulsar Lite Recessed 12W 4000K 24 degree beam angle.







# Studio Power, architect office in Salford.







The collaboration between RICOMAN and Matic in this architect office lighting project showcases the expertise and commitment to delivering exceptional lighting solutions.

To ensure optimal lighting performance and versatility, the **Pulsar adjustable spotlight** was utilized in both track mounted and surface mounted versions. Its **adjustable beam angle**, ranging from narrow to wide, enables precise illumination in different areas of the commercial building. This adaptability makes the Pulsar spotlight an excellent choice for versatile applications throughout the architect office.







# Track lighting

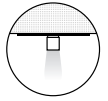

E-Pro is the 3 circuit track version of the E-Pro downlights family. It features a cast aluminium white or black body and a choice of 2x2 or 3x3 square cellular optics created to deliver an extremely low glare rating. Available in 3000K and 4000K colour temperature.



Dimensions in mm

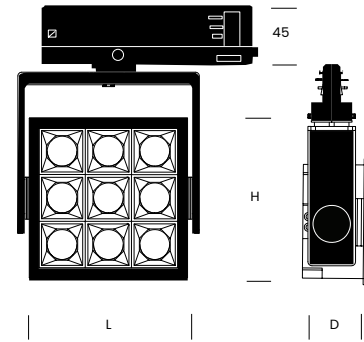

Efficacy	100-106 Lm/W
CRI	>90 Ra
Beam Angle	50°
Operating Hours	50,000
SDCM	≤3
L70 B50	100,000 hours
IP Rating	IP40

## Model

**22**

Model	<b>2x2 cells</b>
Size	<b>L111 x H93 x D47</b>
Wattages	<b>8W / 16W / 28W</b>

**33**

Model	<b>3x3 cells</b>
Size	<b>L149 x H171 x D47</b>
Wattages	<b>18W / 36W / 42W</b>

## Kelvin

<b>/3K</b>	<b>/4K</b>
3000K	4000K

## Colour

<b>/BK</b>	<b>/WT</b>
Black model	White model

## Options

<b>/CC</b>	<b>/DD</b>
CASAMBI controls	DALI dimming

**Code Example** R111733/18W/4K- E-Pro Track 3x3 cells in 18W, 4000K.

R111401

# Zenith Switchable wattage spotlight

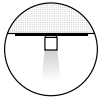

The Zenith 3 Circuit Track Light is a cutting-edge solution for versatile and adjustable LED spotlighting. With switchable wattages, Zenith was designed with precision and performance in mind, this track-mounted luminaire offers a range of features to meet your lighting needs.

Dimensions in mm

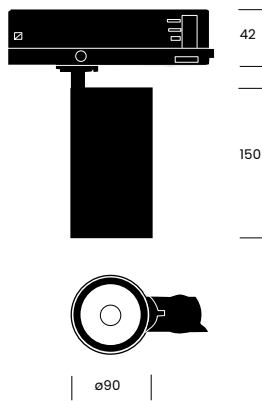

Wattage	12W-42W Switchable
Efficacy	100-106 Lm/W
CRI	>90 Ra
Beam Angle	24°
Operating Hours	50,000
SDCM	≤3
L70 B50	100,000 hours
IP Rating	IP20

Kelvin	/27K		/3K		/4K	
	Kelvin	2700K	Kelvin	3000K	Kelvin	4000K
12W		1140 Lm	12W	1189 Lm	12W	1431 Lm
24W		2136 Lm	24W	2256 Lm	24W	2707 Lm
42W		3344 Lm	42W	3350 Lm	42W	4098 Lm

Colour



**/BK**  
Black model

**/WT**  
White model

Options

- /CC** CASAMBI controls
- /DD** DALI dimming

**Code Example** R111401/3K - Zenith Switchable 12W-42W in 3000K.

Accessories



**/R09-HC75**  
Honeycomb Diffuser

# Pulsar Lite Track

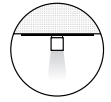

Pulsar Lite is the 3 circuit track version of the Pulsar downlights family. It features a cast aluminium white or black body, a choice of white or black reflector as standard and integral driver. Available in 3000K and 4000K colour temperature and customisable with 15°, 24°, 38° and 55° beam angles, Pulsar provides a complete display lighting solution.

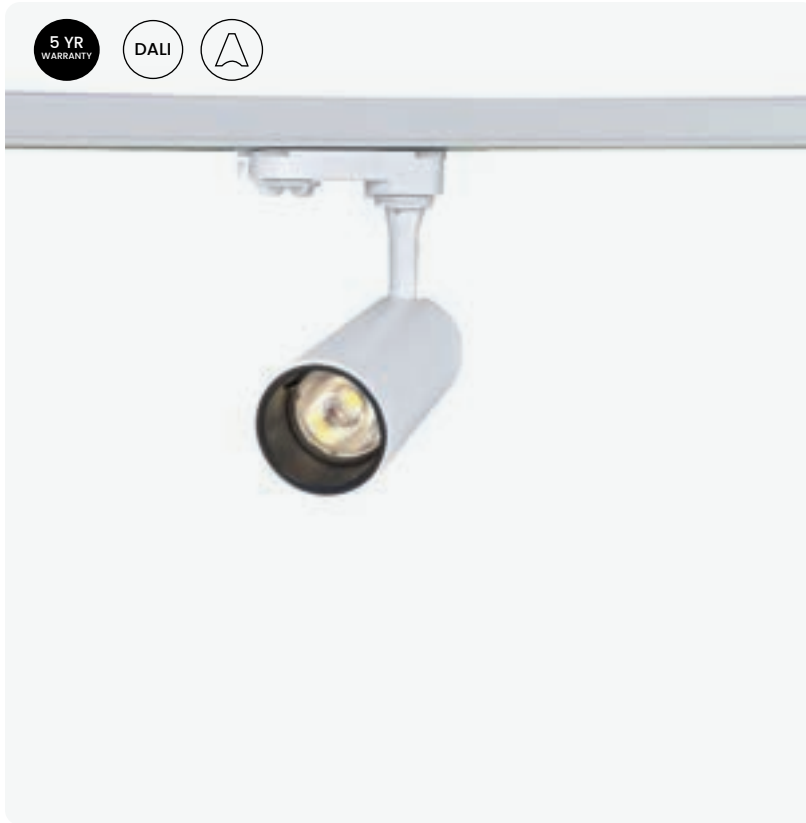

Dimensions in mm



Wattage	12W
Efficacy	90 Lm/W
CRI	>90 Ra
Beam Angle	24° Standard
Operating Hours	50,000
SDCM	≤3
IP Rating	IP20

**Kelvin**

<b>01</b>	<b>02</b>	<b>/27K</b>
3000K	4000K	2700K

**Beam angle**

<b>/15</b>	<b>Standard</b>	<b>/38</b>	<b>/55</b>
15 degree beam angle	24 degree beam angle	38 degree beam angle	55 degree beam angle

**Body Colour**

<b>/BK</b>	<b>/WT</b>
Black body	White body

**Reflector colour**

	
<b>/BR</b>	<b>/WR</b>
Black reflector	White reflector

**Code Example** R096701/BK/WR/15 - Pulsar Lite Track 15° 3000k with black body and white reflector.

**Accessories**



**/R09-HC40**  
Honeycomb  
diffuser

R111721

# Pulsar Pendant Track

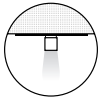

Pulsar pendant track is the 3 circuit track version of the Pulsar pendant. It features a cast aluminium white or black body. Available in 3000K and 4000K colour temperature and customisable with 15°, 24°, 38° and 55° beam angles, Pulsar pendant provides a complete display lighting solution.

Dimensions in mm

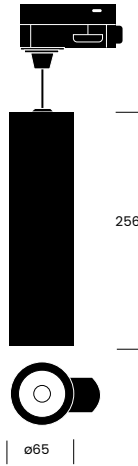

Wattage	10W
Efficacy	90lm/W
CRI	>90 Ra
Beam Angle	38° Standard
Operating Hours	50,000
SDCM	≤3
IP Rating	IP20

<b>Kelvin</b>	<b>/27</b> 2700K	<b>/3K</b> 3000K	<b>/4K</b> 4000K
---------------	---------------------	---------------------	---------------------

<b>Beam angle</b>	<b>/15</b> 15 degree beam angle	<b>/24</b> 24 degree beam angle	<b>standard</b> 38 degree beam angle	<b>/55</b> 55 degree beam angle
-------------------	------------------------------------	------------------------------------	---	------------------------------------

<b>Body Colour</b>	<b>/BK</b> Black body	<b>/WT</b> White body
--------------------	--------------------------	--------------------------

<b>Options</b>	<b>/CC</b> CASAMBI controls	<b>/DD</b> DALI dimming
----------------	--------------------------------	----------------------------

**Code Example** R111721/4K/WT/15 - Pulsar Pendant Track 10W, 4000K IN white with 15 beam angle.

**Accessories**



**/R09-HC40**  
Honeycomb diffuser

# Egress Track exit sign

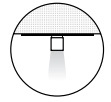

An exit sign for 3 circuit track mounting system featuring LED lamps known for its high efficiency, durability, and low energy consumption.



Dimensions in mm

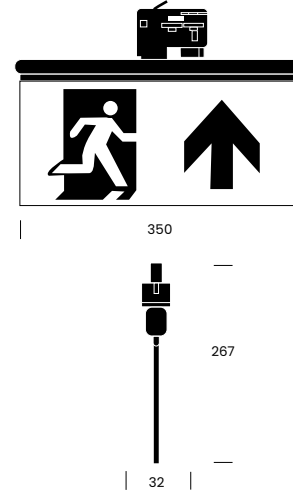

Wattage	2.7W
Lumens	170 Lm/W
Kelvin	6000K
Batery duration	3 hours
Mode of operation	Non-maintained
Battery	LiFePO4, 6.4V, 1.5AH

**Body Colour**    **/BK**    **/WT**  
 Black body      White body

**Legnds**      **/LR**      **/LL**      **/LD**      **/LU**  
 Right legend    Left legend    Down legend    Legend up

**Code Example**    R111222 - Egress Track Exit Sign 2.7W.

R111721

# Draco Track emergency

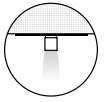

An emergency LED for 3 circuit track mounting system featuring LED lamps known for their high efficiency, durability, and low energy consumption. It is designed to be used with Lithium Iron Phosphate (LiFePO4) batteries, ensuring reliable power backup. Additionally, the system includes a self-test and charge indicator for maintenance.

Dimensions in mm

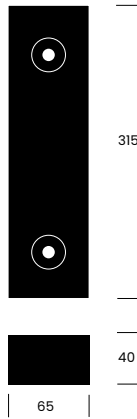

Wattage	3W
Lumens	250 Lm/W
Kelvin	6000K
Battery duration	3 hours
Mode of operation	Non-maintained
Battery	LiFePO4, 6.4V, 1.5AH

Body Colour

**/BK**

Black body

**/WT**

White body

RICOMAN LIGHTING CATALOGUE EDITION 8

Code Example R111221- Draco Track Emergency 3W.

### 3 Circuit Track System

RICOMAN track light range provides an efficient and aesthetically pleasing solution for display lighting. Fully adjustable with differing sizes and wattages allows total flexibility to display lighting projects. Colour rendition over 90 Ra is standard across the RICOMAN track light range, ensuring the object is reflected in the best possible way.



**XTS4**-----  
Surface or suspended track

<b>Sizes</b>	<b>10</b> 1 Metre	<b>20</b> 2 Metres	
<b>Colours</b>	<b>01</b> Silver finish	<b>02</b> Black finish	<b>03</b> White finish



**XTSF4**-----  
Recessed track

<b>Sizes</b>	<b>10</b> 1 meter	<b>20</b> 2 meter	
<b>Colours</b>	<b>01</b> Silver finish	<b>02</b> Black finish	<b>03</b> White finish

**Code Example** XTSF41001- 3 Circuit recessed 1M track in silver

**Mounting options**



**Suspension Mout**

SPW12SK-1/5M	Silver 5m track clamp wire set
SPW12SK-2/5M	Black 5m track clamp wire set
SPW12SK-3/5M	White 5m track clamp wire set



**Surface Mout**

SKB121	Silver surface mount clamp
SKB122	Black surface mount clamp
SKB123	White surface mount clamp



**Surface Mount to Suspended Ceiling**

SKB11T1	Silver suspended ceiling clamp
sKB11T2	Black suspended ceiling clamp
sKB11T3	White suspended ceiling clamp



**Suspension Mout**

PRO-R105-001	Fixing bracket for recessed track
--------------	-----------------------------------

**Accessories for Recessed Mount Track**

XTSF101	Silver recessed feed cover plate
XTSF301	Silver recessed connector cover plate
XTSF102	Black recessed feed cover plate
XTSF302	Black recessed connector cover plate
XTSF103	White recessed feed cover plate
XTSF303	White recessed connector cover plate

**Connectors**



**XTS113**  
Track live end



**XTS143**  
Track connector with middle feed



**XTS213**  
Track straight connector



**XTS233**  
Track flexible corner



**XTS243**  
Track adjustable corner



**XTS343**  
Track L-connector



**XTS353**  
Track L-connector mirror



**XTS363**  
Track T-connector mirror



**XTS373**  
Track T-connector



**XTS383**  
Track X-connector



**XTS393**  
Track T-connector



**XTS403**  
Track T-connector mirror



**XTS413**  
Track dead end cap



**XTSV12**  
Track bending tool

# Zodiac, 48V Track System





Welcome to the Zodiac range of low voltage tracks and track lights from RICOMAN lighting. Available in direct track, direct/indirect track or the stylish round track amount and type of lighting to suit your needs.

# Zodiac, 48V Track System



Track System



Zodiac 48V Direct Track

**Sizes**            **-01**            **-02**  
                          1 Metre            2 Metre

**Accessories**



**-03**  
 Zodiac 48V direct horizontal 'I' Connector shape



**-04**  
 Zodiac 48V direct end caps (2 pcs)



Zodiac 48V Direct / Indirect Track

**Sizes**            **-11**            **-12**  
                          1 Metre            2 Metre

**Accessories**



**-13**  
 Zodiac 48V direct/indirect horizontal 'I' connector Shape



**-14**  
 Zodiac 48V direct/indirect end caps (2 pcs)

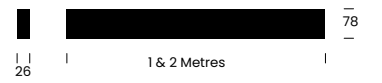

Zodiac 48V Round Track

**Sizes**            **-21**            **-22**  
                          1 Metre            2 Metre



**-23**  
 Zodiac 48V round horizontal 'I' connector Shape



**-24**  
 Zodiac 48V round end caps (2 pcs)



**Options**            **/DD**  
                          DALI dimming

**Code Example**    R112-21 - 1M Zodiac 48V Round Track

**Accessories**

<b>R112-05</b>	Zodiac 48V Recessed Installation Kit
<b>R112-31</b>	Zodiac 48V Track Mechanical Connector Plate
<b>R112-32</b>	Zodiac 48V Track Suspension Kit
<b>R112-33</b>	Zodiac 48V Track Black Cover Strip 1m
<b>R112-34</b>	Zodiac 48V Track Flexible Electrical Connector
<b>R112-37</b>	Zodiac 48V Track Straight Electrical Connector
<b>R112-35/150W</b>	Zodiac 48V Track Internal Driver 150W
<b>R112-36</b>	Zodiac 48V Track Power Connector for External Driver

## Zodiac, 48V Track System

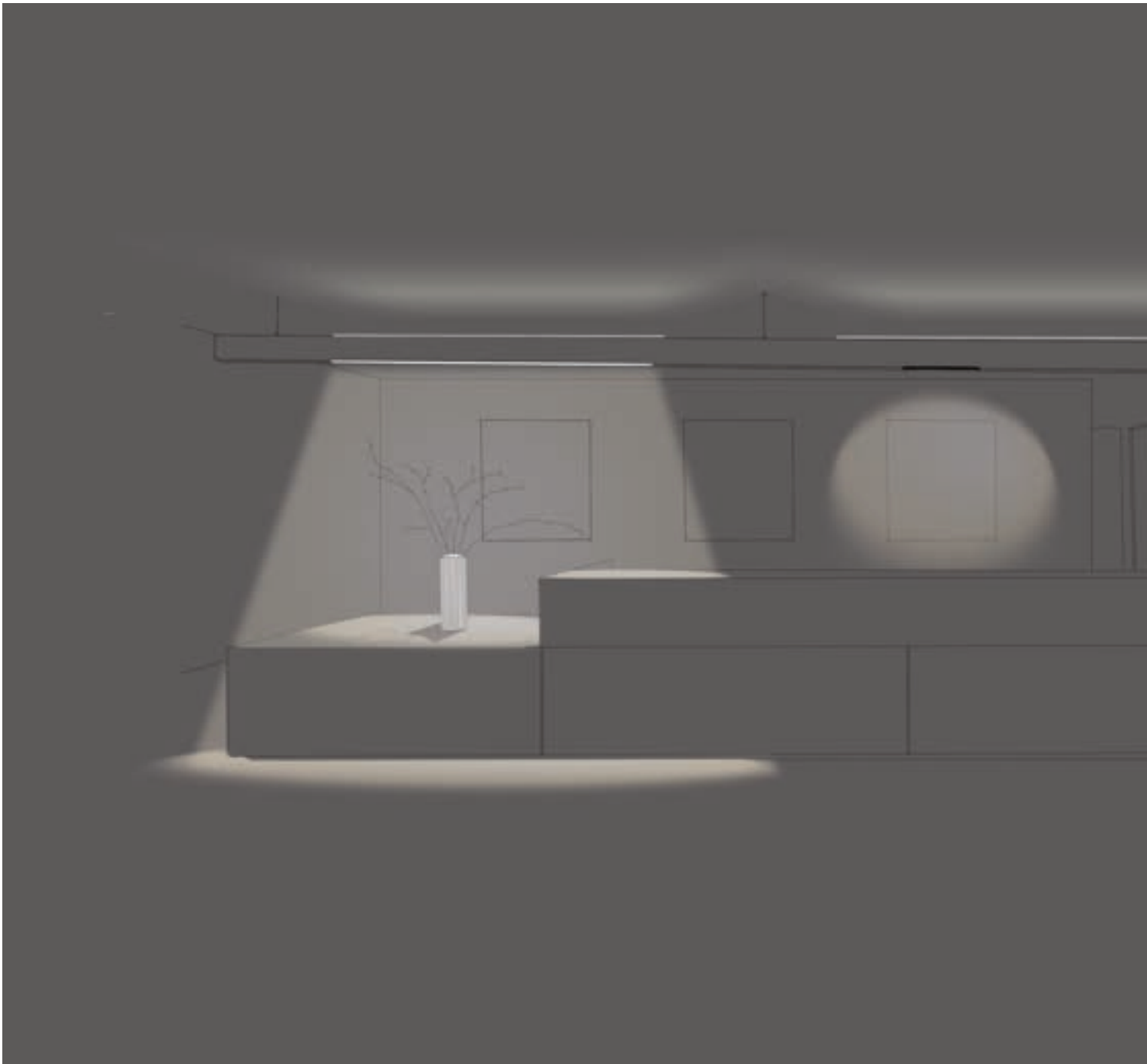

RICOMAN's Zodiac 48V Track System delivers a sleek, versatile lighting solution for modern homes, offices, and commercial spaces. With options for both **direct** & **indirect** lighting, it even includes a **Bluetooth speaker** for added functionality.



### Zodiac Linear

**Model**

**021**

Zodiac 48V track linear 7W - 300m

**022**

Zodiac 48V track linear 15W - 600mm

**028**

Zodiac 48V track linear up 5W - 300mm

**023**

Zodiac 48V Track linear Wallwash 12W

**Kelvin**

**/3K**

3000K

**/4K**

4000K



### Zodiac Recessed Aperture

**Model**

**024**

Zodiac 48V track Recessed Aperture 6W

**026**

Zodiac 48V track Adjustable Recessed Aperture 6W

**Kelvin**

**/3K**

3000K

**/4K**

4000K

# Zodiac, 48V Track System



## Zodiac Spotlights

Model	042	044	046	045	047
	Zodiac 48V track Zoomable spot 9W	Zodiac 48V track up spot 5W	Zodiac 48V track spot 18W	Zodiac 48V track spot 10W	Zodiac 48V track spot 24w
Kelvin	<b>/3K</b> 3000K	<b>/4K</b> 4000K			

The Zodiac Spot range from RICOMAN lighting offers a versatile and efficient lighting solution that is ideal for highlighting specific areas or features in your space. This range features a variety of low voltage track lights that offer focused, directional lighting to create a dramatic effect in your space.

Sound & light, all in one track.



**Zodiac Speaker**

Bluetooth Distance **10 Metres without obstacles**

Transmission Power **12DB**

Output Power **10W**

**Model**      **011**      **012**  
Master Speaker      Slave Speaker

## Zodiac, 48V Track System



This range features a variety of decorative lighting fixtures that offer both direct and indirect lighting to create a warm and welcoming atmosphere in your home or office.



**Zodiac Beam**

**Model**

**004**  
Zodiac 48V track  
beam 12w

**Kelvin**

**/3k**  
3000K

# Zodiac, 48V Track System

The decorative lights are available in a range of styles, finishes, and colour temperatures, so you can customise the lighting in your space to match your decor and style.



**Zodiac Ring**

<b>Model</b>	<b>006</b> Zodiac 48V track ring 5W	<b>005</b> Zodiac 48V track ring pendant 5W
--------------	--	--

<b>Kelvin</b>	<b>/3K</b> 3000K	<b>/4K</b> 4000K
---------------	---------------------	---------------------



**Zodiac Globe**

<b>Model</b>	<b>002</b> Zodiac 48V track globe surface 5W	<b>031</b> Zodiac 48V track globe pendant 5W
--------------	---	---

<b>Kelvin</b>	<b>/3K</b> 3000K
---------------	---------------------



**Flexible Neon**

<b>Model</b>	<b>048</b> ø22 x 500	<b>049</b> ø22 x 1000	<b>050</b> ø22 x 1500
--------------	-------------------------	--------------------------	--------------------------

<b>Kelvin</b>	<b>/3K</b> 3000K
---------------	---------------------



# Zodiac, 48V Track System



The Zodiac Pendant range from RICOMAN lighting offers a stylish and functional lighting solution that is perfect for creating a cosy and inviting atmosphere in your home or office.



**Zodiac Drop Pendant**

**Model**      **032**  
 Zodiac 48v track  
 drop pendant 7w

**Kelvin**      **/3K**      **/4K**  
 3000K      4000K



**Zodiac Cylindrical Pendant**

**Model**      **034**      **033**  
 Zodiac 48V track  
 brass cylindrical  
 pendant 7W      Zodiac 48V track  
 black cylindrical  
 pendant 7W

**Kelvin**      **/3K**      **/4K**  
 3000K      4000K







# Recessed modular lighting

R101281

# Core Plus backlit panel light



A backlit, flicker-free cost efficient LED panel light featuring slim line aluminium body and an opal diffuser for general, circulation and feature areas. Available with various mounting options to maximise versatility.



Dimensions in mm

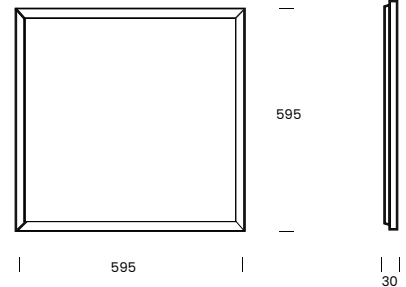

Efficacy	105lm/W
CRI	>80 Ra
Beam Angle	110°
Operating Hours	30,000
SDCM	≤6
L70 B50	50,000 hours
IP Rating	IP40

<b>Wattage</b>	<b>/24W</b>	<b>Standard</b>	<b>/45W</b>
	24W	32W	45W

<b>Kelvin</b>	<b>/4K</b>		<b>/5K</b>	
	24W	2532Lm	24W	2607Lm
	32W	3362Lm	32W	3362Lm
	45W	4750Lm	45W	4892Lm

<b>Options</b>	<b>/DH</b>	<b>/DD</b>	<b>/DL</b>	<b>/DSI</b>
	Mains dimming	DALI dimming	0-10V dimming	DSI dimming

**Code Example** R101281/24W - Core Plus Panel 600x600mm 24W 4000K

**Accessories**

<b>RE36</b>	Core 4 Point Suspension Kit
<b>RE60</b>	70mm deep surface mounting frame 6x6
<b>RE10</b>	Burgess Clips
<b>RE13</b>	Metal pan ceiling brackets
<b>RE160</b>	Recessed Frame 6x6

# Core UGR backlit TP(a) panel



Core UGR is a backlit, flicker-free LED panel featuring an opal TP(a) rated diffuser for a number of applications. The panel series is available in 6x6, 12x3 and 12x6 sizes with various mounting options such as lay in exposed T ceilings, surface mounted, suspended and burgess ceilings.

Dimensions in mm

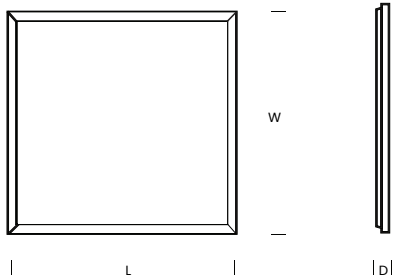

Efficacy	105Lm/W
CRI	>83 Ra
Beam Angle	130°
Operating Hours	50,000
SDCM	≤6
L70 B50	50,000 hours
IP Rating	IP40

Size	82	83	84
	L600xW600xD30	L1200xW300xD30	L1200xW600xD30

Wattage	/24W	/32W	/45W	/64W
	Available for the 6x6 panel	Available for the 6x6 and 12x3 panel	Available for the 6x6 panel	Available for the 12x6 panel

Kelvin	/4K
24W	2532Lm
32W	3358Lm
45W	4727Lm
64W	6717Lm

Options	/DH	/DD	/DL	/DSI
	Mains dimming	DALI dimming	0-10V dimming	DSI dimming

**Code Example** RI01282/24W - Core UGR Panel 600x600mm 24W 4000K

**Accessories**

<b>RE36</b>	Core 4 Point Suspension Kit
<b>RE10</b>	Burgess Clips
<b>RE13</b>	Metal pan ceiling brackets
<b>RE123</b>	70mm deep surface mounting frame 12x3
<b>RE126</b>	70mm deep surface mounting frame 12x6

# Aquavance IP66 rated panel



An IP66 rated and flicker free LED panel light, ideal for medical applications and high humidity areas. Aquavance comes in different size and wattage options, offering exceptional lumen output along with maximum installation versatility making it suitable for a number of different areas and uses.



5 YR WARRANTY

Dimensions in mm

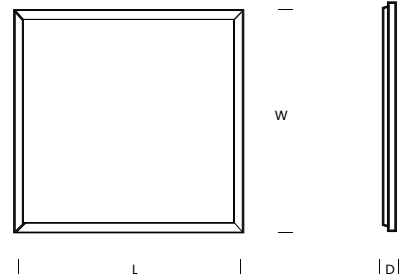

Efficacy	100Lm/W
CRI	>85 Ra
Beam Angle	110°
Operating Hours	50,000
SDCM	≤3
L70 B50	100,000 hours
IP Rating	IP66

Size	11	12	13
	L600xW600xD12.5	L1200xW300xD12.5	L1200xW600xD12.5

Wattage	03	01	301
	36W	48W	72W

### Accessories

<b>RE1</b>	4-point suspension kit
<b>RE2</b>	Z-Clips - plasterboard ceilings
<b>RE04</b>	Driver Plate
<b>RE6</b>	Y Suspension Kit
<b>RE7</b>	Offset Bracket
<b>RE8</b>	Linear Clips
<b>RE10</b>	Burgess Clips
<b>RE19</b>	Surface Mounting Frame 1200x300mm
<b>RE60</b>	70mm deep surface mounting frame 6x6
<b>RE123</b>	70mm deep surface mounting frame 12x3
<b>RE126</b>	70mm deep surface mounting frame 12x6
<b>RE160</b>	Recessed Frame 6x6

**Code Example** R10I203 - Aquavance Panel 1200x300mm 36W 5000K



**Alderley Edge Medical Centre** in Alderley Edge.  
Aquavance IP66 panel light.

# Pure 5x5 panel



LED panel light ideal for general commercial applications. Pure Panel range comes in 5x5 with dimming and emergency options available. The innovative back channel allows various mounting options to maximise versatility.



Dimensions in mm

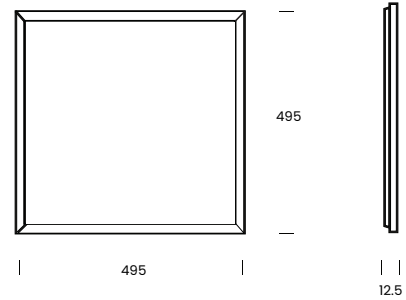

Wattage	30W
Efficacy	100lm/W
Kelvin	4000K
CRI	>85 Ra
Beam Angle	120°
Operating Hours	50,000
SDCM	≤4
L70 B50	70,000 hours
IP Rating	IP44

**Options**

**/DH**

Mains dimming

**/DD**

DALI dimming

**/DL**

0-10V dimming

**/DSI**

DSI dimming

**Accessories**

<b>RE1</b>	4-point suspension kit
<b>RE2</b>	Z-Clips - plasterboard ceilings
<b>RE04</b>	Driver Plate
<b>RE6</b>	Y Suspension Kit
<b>RE7</b>	Offset Bracket
<b>RE8</b>	Linear Clips
<b>RE10</b>	Burgess Clips

**Code Example** R101191/4K - Pure Panel 500x500mm 30W 4000K

# Libra switchable wattage



Libra is a cutting-edge low glare panel light that seamlessly blends functionality with a sleek and stylish design. This innovative lighting solution is equipped with the unique ability to switch between wattages and colour temperatures, offering users unparalleled flexibility and control over their lighting environment.

Dimensions in mm

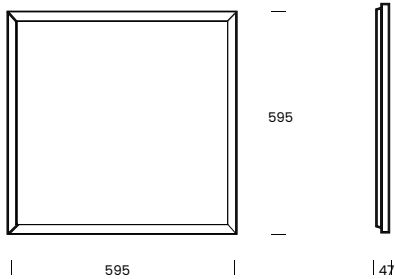

Wattage	24W   36W Switchable Wattage
Efficacy	112 Lm/W   107 Lm/W
Kelvin	3000K   4000K   5700K
CRI	>90 Ra
Beam Angle	110°
Operating Hours	50,000
IP Rating	IP20

**Options**

- /DH**  
Mains dimming
- /DD**  
DALI dimming
- /DL**  
0-10V dimming
- /DSI**  
DSI dimming
- /PRI**  
PRI
- /CC**  
Casambi

**Code Example** R172201- Libra Switchable Wattage (24W | 36W) and Colour Temperature (3000K | 4000K | 5700K)

**Accessories**

RE36	<b>Core 4 Point Suspension Kit</b>
RE60	<b>70mm deep surface mounting frame 6x6</b>
RE13	<b>Metal pan ceiling brackets</b>
RE160	<b>Recessed Frame 6x6</b>

R101107

# CTC changing panel light



A tunable white 2500-6500K LED panel light with innovative back channel allowing for a number of installations. CTC is IP44 rated, dimmable as standard and offers control via a wall mounted or a remote control. The innovative back channel allows various mounting options to maximise versatility.



Dimensions in mm

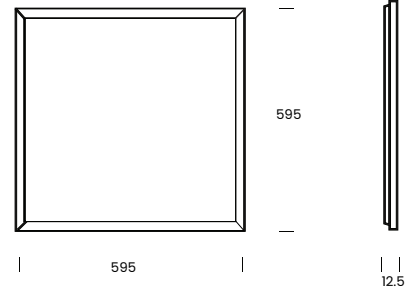

Wattage	36W
Efficacy	84lm/W
Kelvin	2500K - 6500K
CRI	>80 Ra
Beam Angle	120°
Operating Hours	50,000
SDCM	≤4
L70 B50	70,000 hours
IP Rating	IP44

**Options**

**/DMX**  
DMX controls

**/cc**  
Casambi control

**Accessories**

<b>RE1</b>	4-point suspension kit
<b>RE2</b>	Z-Clips - plasterboard ceilings
<b>RE04</b>	Driver Plate
<b>RE6</b>	Y Suspension Kit
<b>RE7</b>	Offset Bracket
<b>RE8</b>	Linear Clips
<b>RE10</b>	Burgess Clips
<b>RE60</b>	70mm deep surface mounting frame 6x6
<b>RE160</b>	Recessed Frame 6x6

**Code Example** RR101107 - CTC Panel 600x600mm 36W 2500K-6500K Dimmable.

**R101106/RGBW** **RGBW** colour changing panel light



A colour changing dimmable 600x600 LED panel light ideal for creating a unique atmosphere. RGBW offers wall, remote control and DMX based control options. The innovative back channel allows various mounting options to maximise versatility.

Dimensions in mm

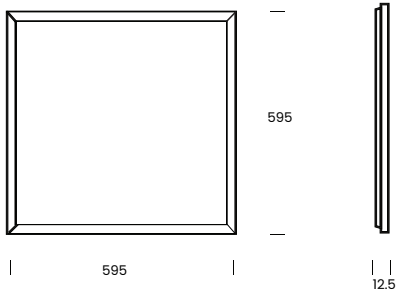

Wattage	36W
Efficacy	49Lm/W
Kelvin	RGBW
CRI	>80 Ra
Beam Angle	120°
Operating Hours	50,000
SDCM	≤4
L70 B50	70,000 hours
IP Rating	IP44



RICOMAN LIGHTING CATALOGUE EDITION 8

<b>Options</b>	<b>/DMX</b>	<b>/cc</b>
	DMX controls	Casambi control

**Code Example** R101106/RGBW - RGBW Panel 600x600mm 36W Dimmable.

**Accessories**

<b>RE1</b>	4-point suspension kit
<b>RE2</b>	Z-Clips - plasterboard ceilings
<b>RE04</b>	Driver Plate
<b>RE6</b>	Y Suspension Kit
<b>RE7</b>	Offset Bracket
<b>RE8</b>	Linear Clips
<b>RE10</b>	Burgess Clips
<b>RE60</b>	70mm deep surface mounting frame 6x6
<b>RE160</b>	Recessed Frame 6x6

# Sky Panels



A single or set of 4, 6, 9 backlit, flicker-free cost efficient LED panel lights featuring slim line aluminium body and a printed sky effect. Ideal for creating a natural feature lighting effect and a unique atmosphere in any workplace. Panel lights with custom graphics are also available.



5 YR WARRANTY

Dimensions in mm

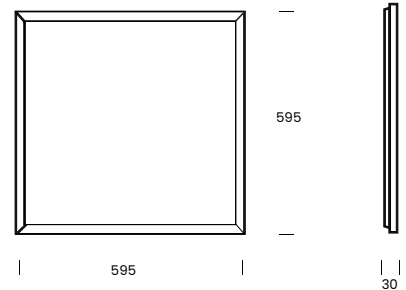





Efficacy	105lm/W
Kelvin	2500K - 6500K
CRI	>80 Ra
Beam Angle	110°
Operating Hours	50,000
SDCM	≤6
L70 B50	50,000 hours
IP Rating	IP44

<b>Sets</b>	<b>1</b> 1 panel	<b>4</b> Set of 4 panels	<b>6</b> Set of 6 panels	<b>9</b> Set of 9 panels
-------------	---------------------	-----------------------------	-----------------------------	-----------------------------

<b>Size</b>	<b>Standard</b> L600xH600xD30	<b>/123</b> L1200xH300xD30	<b>/126</b> L1200xH600xD30
-------------	----------------------------------	-------------------------------	-------------------------------

<b>Options</b>	<b>/DH</b> Mains dimming	<b>/DD</b> DALI dimming	<b>/DL</b> 0-10V dimming	<b>/DSI</b> DSI dimming
----------------	-----------------------------	----------------------------	-----------------------------	----------------------------

**Designs**

				
Sky	Trees	Ballons	Sea	Custom

**Code Example** R101294 - Set of 4 600x600 Sky Panels.

**Accessories**

<b>RE36</b>	Core 4 Point Suspension Kit
<b>RE60</b>	70mm deep surface mounting frame 6x6
<b>RE10</b>	Burgess Clips
<b>RE13</b>	Metal pan ceiling brackets
<b>RE160</b>	Recessed Frame 6x6



## Accessories

At RICOMAN, we offer a comprehensive range of panel accessories designed to provide flexibility and ease of installation for various ceiling types. Our accessories include solutions for suspended, surface, and recessed frames, ensuring that our panels can be seamlessly integrated into any environment.

For metal pan and Burgess ceiling installations, our RE13 and RE10 accessories are specifically designed to solve the challenge of securely and efficiently luminaire lighting into these ceiling types. They offer a reliable solution, ensuring quick and hassle-free installation without compromising the structural integrity of the ceiling.

### Accessories

<b>RE01</b>	4-point suspension kit (Pack of 4)
<b>RE02</b>	Z-Clips (Pack of 4) - plasterboard ceilings
<b>RE04</b>	Driver Plate
<b>RE06</b>	Y Suspension Kit
<b>RE07</b>	Offset Bracket (Pack of 4)
<b>RE08</b>	Linear Clips (Pack of 4)
<b>RE10</b>	Burgess Clips (Pack of 2) - purchased with a RICOMAN panel
<b>RE13</b>	4-Piece metal pan ceiling brackets
<b>RE19</b>	Surface Mounting Frame 1200x300mm
<b>RE36</b>	4 - point suspension kit for Core Panels
<b>RE60</b>	70mm Deep Surface Mounting Frame 600x600mm
<b>RE123</b>	70mm Deep Surface Mounting Frame 1200x300mm
<b>RE126</b>	70mm Deep Surface Mounting Frame 1200x600mm
<b>RE160</b>	Recessed Frame 600x600mm
<b>RE130120</b>	Recessed Frame 1200x300mm
<b>RE160120</b>	Recessed Frame 1200x600mm



**RE13**  
Piece metal pan ceiling brackets



**RE10**  
Burgess Clips



**RE130120**  
Recessed Frame 600x600mm







# Local Blackfriars, luxury apartments in Manchester.







The outcome of the Local Blackfriars project is excellent, with **Beacon** complimenting an excellent design aesthetic of the building. Optimum light levels goes together and adding style with the luminaires' architectural appearance.



# Outdoor lighting

# Beacon

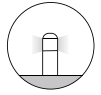

Beacon is a robust exterior IP65 die-cast aluminium LED bollard with a classic look suitable for most applications. Easy install, Beacon is ideal along driveways or footpaths. It comes in 3000K or 4000K with dome, flat or louvre effect.



Dimensions in mm



Wattage	25W
Efficacy	~80lm/W
CRI	>80 Ra
Beam Angle	90°
Operating Hours	50,000
SDCM	≤4
L70 B50	100,000 hours
IP Rating	IP65

**Design**



**14**

Dome

**24**

Flat Top

**34**

Louvre

**Kelvin**

**/3K**  
3000K

**/4K**  
4000K

**Accessories**



**R3010-01**  
Root Mount Kit

**Code Example** R301014/4K - Beacon with dome in 4000K



**Local Blackfriars, luxury apartments** in Manchester  
Client: DOMIS

R301050

# Porcini

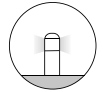

The Porcini bollard light is a stylish and architectural light that is perfect for outdoor applications. The mushroom shaped design is both unique and eye-catching, and the switchable colour temperature allows you to choose the perfect light for your setting. The 25W LED delivers 1100 lumens of light, available in either a 500mm or 1000mm height. The flange mount makes it easy to install, with an optional root mount kit available.

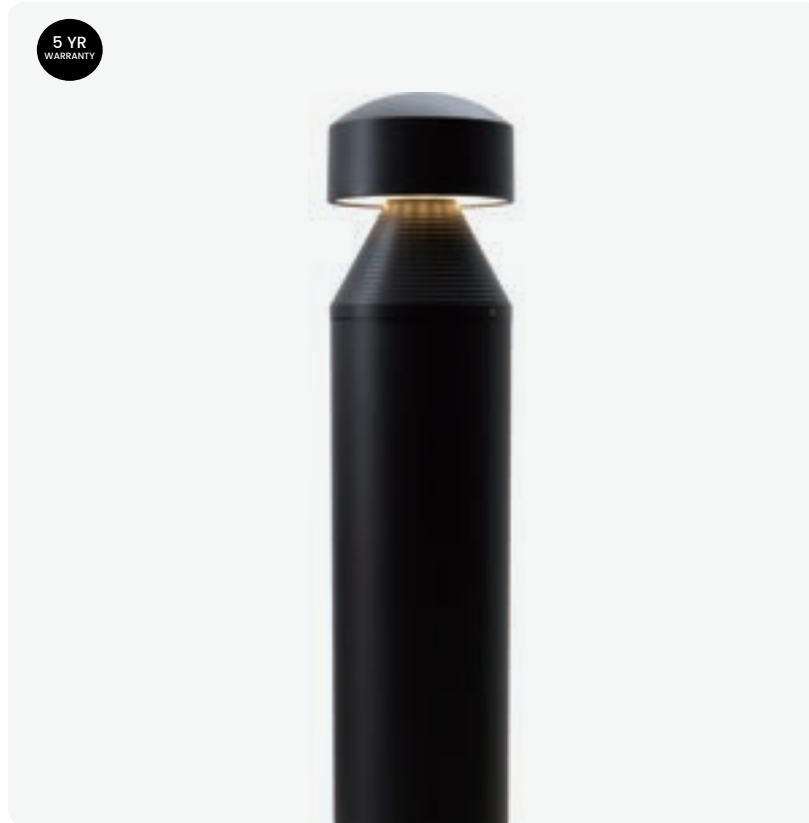

Dimensions in mm

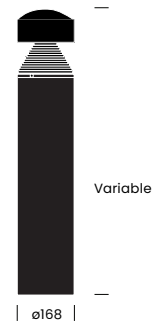

Wattage	25W
Efficacy	44lm/W
Finish	Black
Kelvin	3000K/4000K (Switchable)
CRI	>80 Ra
Beam Angle	60°
Operating Hours	50,000
IP Rating	IP65

Size      **/P500**      **/P1000**  
                  500mm height      1000mm height

### Accessories



**R3010-01**  
Root Mount Kit

**Code Example**      R301050/P500 - Porcini 500mm

R301040

# Silbar

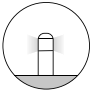

The Silbar bollard light is a stylish and architectural light that is perfect for outdoor applications. The sleek, cylindrical shape is reminiscent of a whistle, and the tempered glass lens adds a touch of sophistication. The aluminum body is both impact- and corrosion resistant, making it ideal for use in harsh outdoor environments. Available in a choice of 800 or 1000mm heights each delivering 15W of 3000K light.

Dimensions in mm

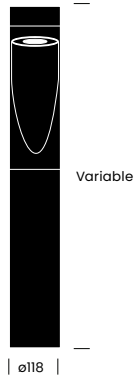

Wattage	15W
Efficacy	70Lm/W
Finish	Grey
CRI	>80 Ra
Beam Angle	130°
Operating Hours	50,000
IP Rating	IP65

<b>Size</b>	<b>/P500</b> 500mm height	<b>/P1000</b> 1000mm height
-------------	------------------------------	--------------------------------

<b>Kelvin</b>	<b>Standard</b> 3000K
---------------	--------------------------



5 YR  
WARRANTY

RICOMAN LIGHTING CATALOGUE EDITION 8

**Code Example** R301040/P800 - Silbar 800mm

# Hydra flood light



A robust and lightweight die-cast aluminium floodlight, suitable for different exterior and industrial applications. With IP65, IK08 protection and a high efficacy of 120Lm/W, Hydra offers four power and size options to cover the needs of different environments.



Dimensions in mm

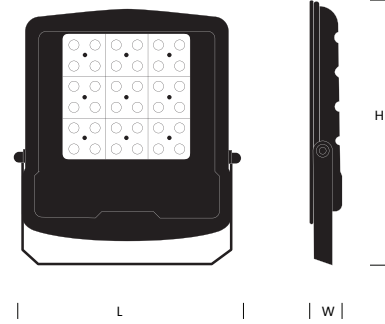

Finish	Black
Kelvin	5000K
CRI	>80 Ra
Beam Angle	145°
Operating Hours	50,000
SDCM	≤4
L70 B50	100,000 hours
IP Rating	IP65

Wattage	/50W	/100W	/150W	/200W
Size	<b>H237 x L200 x W39</b>	Size <b>H321 x L282 x W41</b>	Size <b>H333 x L420 x W51</b>	Size <b>H395 x L470 x W51</b>
Lumens	<b>5654Lm</b>	Lumens <b>13904Lm</b>	Lumens <b>19119Lm</b>	Lumens <b>27744Lm</b>
Wattage	<b>50W</b>	Wattage <b>100W</b>	Wattage <b>150W</b>	Wattage <b>200W</b>

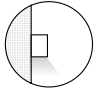

Exterior wall pack IP65 and IK10 rated, in three different finish options. Flosse is available in three outputs delivering up to 3500 lumens. With a modern and minimalist design, screw-less from front with back or side cable entry options, it is ideal for many different exterior applications.

Dimensions in mm

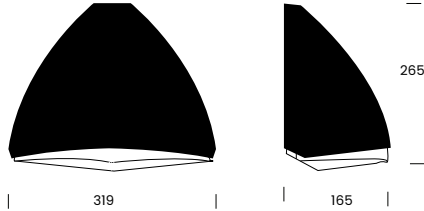

Wattage	15W
Efficacy	70Lm/W
CRI	>80 Ra
Beam Angle	120°
Operating Hours	50,000
SDCM	≤6
IP Rating	IP65

Kelvin	/3K		/4K	
	13W	1711Lm	13W	1757Lm
18W	2385Lm	18W	2453Lm	
28W	3403Lm	28W	3487Lm	

Colour	/BK	/WT	/AN
	Black body	White body	Anthracite body

Wattage	/13W	/18W	/28W
	13W	18W	28W

Options	/E	/MW
	3 hour emergency	Sensor

**Code Example** R301301/BK/3K/18W/E - Flosse 18W, black body in 3000K with emergency.



# Bulkheads



A surface mounted luminaire with subtle architectural styling ideal for decorative interior and exterior applications. With a black or grey cast aluminium body and a TP(α) opal diffuser, Iris also offers an eyelid version. Integral emergency and microwave detector options are available too, as well as combinations.



Dimensions in mm

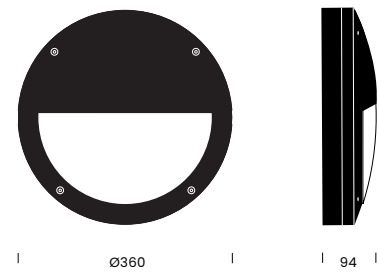

Kelvin	4000K
CRI	>90 Ra
Beam Angle	120°
Operating Hours	50,000
SDCM	≤
L70 B50	70,000 hours
IP Rating	IP65

**Colour**      **/BK**      **/GR**  
 Black body      Grey Body

<b>Wattage</b>	<b>/18W</b>		<b>/22W</b>	
	Wattage	18W	Wattage	<b>22W</b>
Open	1831Lm	Open	<b>2241Lm</b>	
Eyelid	1561Lm	Eyelid	<b>1910Lm</b>	

**Model**



**/OP**      **/EY**  
 Open      Eyelid

**Options**      **/DH**      **/DD**      **/DL**      **/DSI**      **/MW**      **/E**      **/E-Z10**  
 Mains dimming      DALI dimming      0-10V dimming      DSI dimming      Sensor      3 hour emergency      Z10 Integral emergency with remote control testing

**Code Example**      R181701/BK/18W/OP - Iris 18W 4000K Black Finish Open



**Hallam Towers** in Sheffield.  
Iris with eyelid.

# Alphard Round

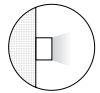

A robust and lightweight die-cast aluminium floodlight, suitable for different exterior and industrial applications. With IP65, IK08 protection and a high efficacy of 120Lm/W, Hydra offers four power and size options to cover the needs of different environments.



Dimensions in mm

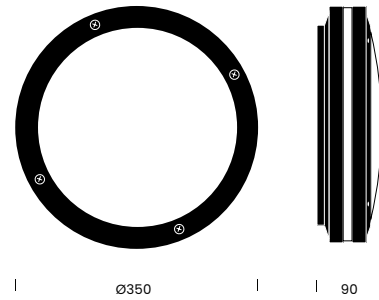

Wattage	24W
Efficacy	85Lm/W
Kelvin	5000K
CRI	>90 Ra
Beam Angle	120°
Operating Hours	50,000
SDCM	≤3
L70 B50	70,000 hours
IP Rating	IP65

**Colour**      **/BK**      **/WT**  
 Black body standard      White Body

**Kelvin**      **/4K**      **/5K**  
 4000K      5000K

**Options**      **/DH**      **/DD**      **/DL**      **/MW**      **/E**      **/E-Z10**  
 Mains dimming      DALI dimming      0-10V dimming      Sensor      3 hour emergency      Z10 Integral emergency with remote control testing

**Code Example**      R181101/4K - Black Alphard Bulkhead 24W 4000K



**Local Blackfriars** in Manchester.  
Alphard Round.

# Alphard Square

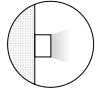

A surface mounted architectural halo bulkhead with a cast aluminium IK10 rated body, black as standard. It is designed for optimal light diffusion, ideal for decorative interior and exterior applications. Integral emergency and microwave detector options are available as well as combinations.



Dimensions in mm

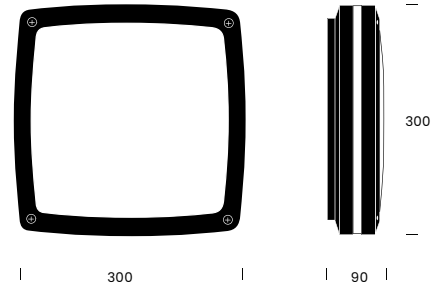

Wattage	24W
Efficacy	85Lm/W
Kelvin	4000K
CRI	>90 Ra
Beam Angle	120°
Operating Hours	50,000
SDCM	≤3
L70 B50	70,000 hours
IP Rating	IP65

**Colour**      **/BK**      **/WT**  
 Black body standard      White Body

**Kelvin**      **/4K**      **/5K**  
 4000K      5000K

**Options**      **/DH**      **/DD**      **/DL**      **/MW**      **/E**      **/E-Z10**  
 Mains dimming      DALI dimming      0-10V dimming      Sensor      3 hour emergency      Z10 Integral emergency with remote control testing

**Code Example**      R181301/4K/E - Black Alphard Square Bulkhead 24W 4000K Emergency

R181401

# Nexus, switchable wattages & colour temperature bulkhead

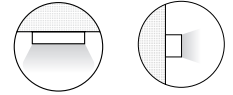

Surface mounted LED luminaire with switchable colour temperature and wattage, that is particularly fast and easy to install. IP65 rated, Nexus is suitable for high humidity areas and can be used for interior or exterior applications. White as standard, it is also available with integral microwave, emergency or combination.

Dimensions in mm

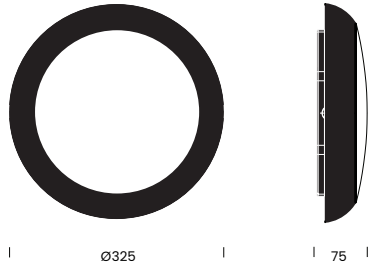

Wattage	9W / 12W / 16W
Efficacy	139Lm/W
Kelvin	3000K / 4000K / 5000K / 6000K
CRI	>85 Ra
Beam Angle	120°
Operating Hours	50,000
SDCM	≤3
L70 B50	70,000 hours
IP Rating	IP65



RICOMAN LIGHTING CATALOGUE EDITION 8

## Accessories

**R181-BK-OP** Nexus Black Open Bezel

**R181-BK-EYE** Nexus Black Eyelid Bezel

**R181-WT-EYE** Nexus White Eyelid Bezel

**R181-GR-OP** Nexus Grey Open Bezel

**R181-01** Nexus Plug In Sensor Pack

**R181-02** Nexus Plug In Emergency Pack

**Code Example** R181401 - Nexus White Open Bezel 3k/4k/5k/6k, 9W, 12W, 16W



# Industrial lighting

# Thanos multi bay

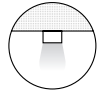

Thanos is a linear light low bay to high bay, with a choice of racking aisle optics using a narrow lens to direct the light as required for the aisle lighting. It offers a choice of speciality beam angles of 30°, 60° and 120° depending required spread. IK10 rating is available with wire guard. It is suitable for various installation types such as surface mounted, suspended, trunking and conduit pendant.



Dimensions in mm

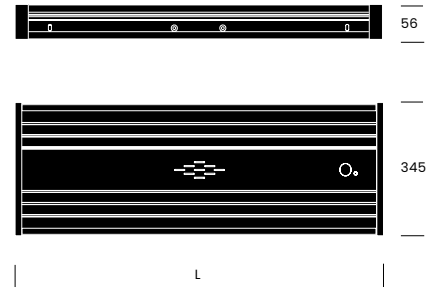

Efficacy	150Lm/W
Kelvin	4000K
CRI	>80 Ra
Beam Angle	120° Standard
Operating Hours	50,000
SDCM	≤3
L70 B50	100,000 hours
IP Rating	IP40

Wattage	/70W	/100W	/150W	/200W
Wattage	<b>70W</b>	Wattage <b>100W</b>	Wattage <b>150W</b>	Wattage <b>200W</b>
Lumens	<b>10862Lm</b>	Lumens <b>15010Lm</b>	Lumens <b>22530Lm</b>	Lumens <b>28015Lm</b>
Length	<b>600</b>	Length <b>600</b>	Length <b>600</b>	Length <b>600</b>
	<b>/320W</b>			
Wattage	<b>320W</b>			
Lumens	<b>41857Lm</b>			
Length	<b>1200</b>			

Beam Angle	/B30	/B60	Standard
	30 degree beam angle	60 degree beam angle	120 degree beam angle

Options	/E	/DD	/PIR
	3 hour emergency	DALI dimming	Sensor

**Code Example** R141400/70W - Thanos 70W 4000K 120° beam 0-10V dim

**Accessories**

<b>R141-01</b>	Conduit rod suspension kit
<b>R141-03</b>	Multiple application fixing bracket
<b>R141-04</b>	Wire guard

# Canopus high bay

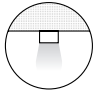

Canopus is a robust yet flexible IP65 aluminium multi-purpose LED high bay/ low bay offering a 7-year warranty. With adjustable beam angles and adjustable stirrup arm features ultimate flexibility in beam angle positioning. Canopus is available in three sizes/outputs with emergency and sensor options.

Dimensions in mm

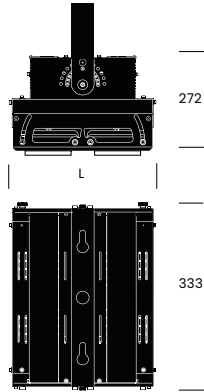

Efficacy	117Lm/W
Kelvin	5000K
CRI	>83 Ra
Beam Angle	120°
Operating Hours	50,000
SDCM	≤4
L70 B50	70,000 hours
IP Rating	IP65

Wattage	01	02	03
Wattage	<b>100W</b>	Wattage <b>150W</b>	Wattage <b>200W</b>
Lumens	<b>11742Lm</b>	Lumens <b>16982Lm</b>	Lumens <b>22846Lm</b>
Length	<b>257</b>	Length <b>380</b>	Length <b>499</b>

Options	/DD	/DL	/PIR	/E
	DALI dimming	0-10V dimming	Sensor	3 hour emergency

**Code Example** R123101- Canopus 100W 5000K

**Accessories**

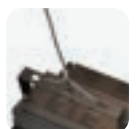

**RE12**  
1M suspension chain

# Titan switchable wattage & non-corrosive

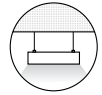

The Titan is an industrial-grade LED light that is ideal for applications that require protection from dirt, dust, water, and impact. It features an IP65 and IK09 rated body, and can be surface mounted or suspended. The Titan is available in four different lengths and four switchable wattages. It is also available with plug in integrated emergency or PIR options.



Dimensions in mm

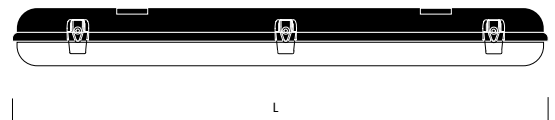
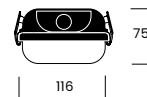

Efficacy	160lm/W
Kelvin	4000K
CRI	>80 Ra
Beam Angle	140°
Operating Hours	50,000
SDCM	≤4
L70 B50	70,000 hours
IP Rating	IP65

Size	06	12	15	18
Wattage	12W / 15W / 18W / 20W	Wattage 24W / 30W / 37W / 40W	Wattage 35W / 46W / 52W / 60W	Wattage 48W / 54W / 70W / 80W
Length	660	Length 1200	Length 1500	Length 1800

**Accessories**



**Code Example** R151012 - Titan 1.2m Switchable 24W/30W/37W/40W in 4000K

**R1510-01**  
Suspension pack



# Orion batten

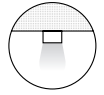

Orion is a highly efficient LED batten suitable for surface, suspended or trunking mounting. With over 130 lumens per watt, it comes in three lengths plus high output versions which makes it ideal for a number of different linear batten applications.



Dimensions in mm



Efficacy	130Lm/W
CRI	>85 Ra
Beam Angle	120°
Operating Hours	50,000
SDCM	≤4
L70 B50	70,000 hours
IP Rating	IP20

Wattage	0101	0102	0201	0202
Wattage	<b>25W</b>	<b>45W</b>	<b>35W</b>	<b>60W</b>
Lumens	<b>3251Lm</b>	<b>5853Lm</b>	<b>4552Lm</b>	<b>7803Lm</b>
Length	<b>1170</b>	<b>1170</b>	<b>1470</b>	<b>1470</b>
	0301	0302		
Wattage	<b>45W</b>	<b>70W</b>		
Lumens	<b>5852Lm</b>	<b>9103Lm</b>		
Length	<b>1734</b>	<b>1734</b>		

Kelvin	/4K	Standard
	4000K	5000K

Options	/DD	/DL	/DSI	/PIR	/E
	DALI dimming	0-10V dimming	DSI dimming	Sensor	3 hour emergency

**Accessories**



**R28-01**  
1.5m suspension kit

**Code Example** R28010/4K - Orion Batten 1.2m 25W 4000K

R2500\_--

# Academy curved linear light

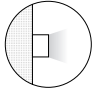

Academy is a series of curved profile linear luminaires with opal TP(a) diffusers for surface mounting or suspension, often used for school and hospital lighting. The series comes in three lengths and 4000K, with integral emergency curved linear light and dimming options.

Dimensions in mm



Efficacy	120Lm/W
Kelvin	4000K
CRI	>85 Ra
Beam Angle	140°
Operating Hours	50,000
SDCM	≤4
L70 B50	70,000 hours
IP Rating	IP20

Length	12	15	18
	1200mm	1500mm	1800mm

Wattage	/20W	/40W	/30W	/60W	/40W	/68W
	Academy 1.2m	Academy 1.2m	Academy 1.5m	Academy 1.5m	Academy 1.8m	Academy 1.8m

Options	/DD	/DL	/DSI	/PIR	/E	/MW
	DALI dimming	0-10V dimming	DSI dimming	Sensor	3 hour emergency	MW Sensor

**Code Example** R250012/20W -Academy 1.2m 20W 4000K

**Accessories**



**R28-01**  
1.5m suspension kit



# Emergency lighting

# Soar II IP65 emergency downlight



Multi purpose surface mounted emergency IP65 downlight, offering both open area and escape route optics. It comes with integral driver and LiFePO4 battery pack which can be ordered as self test or manual test versions. Available as a round or a square version.



3 YR  
WARRANTY

Dimensions in mm

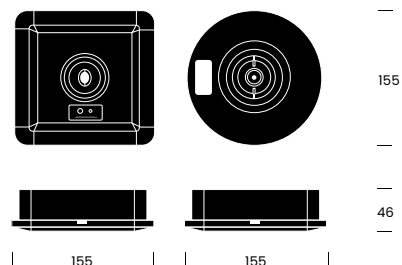

Wattage	2W
Efficacy	115 Lm/W
Kelvin	6500K
CRI	>80 Ra
Beam Angle	150° (Corridor) 80x30° (Open area)
Battery	LiFePO4
Operating Hours	30,000
Maintained	Non maintained
IP Rating	IP65

## Shape



**60**  
Round



**61**  
Square

## Emergency type

**/ST**

Self Test (only available for the white model)

**/MT**

Manual Test

## Colour

**/WT**

White

**/BK**

Black

**Code Example** R221560/MT/BK - Soar 2 Manual test Round Surface Emergency Light in Black 2W

R221503/MT

# Vanguard III emergency downlight

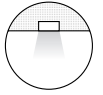

Manual test stand alone 3 hour LED emergency recessed downlight using a LiFePO4 (Lithium Phosphate) battery. It is available with open area and corridor optic options included and comes with integrated electronics.

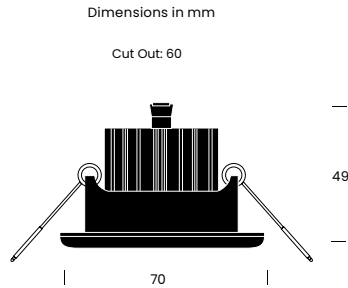

Wattage	3W
Lumen	241
Kelvin	6000K
CRI	>75 Ra
Beam Angle	108°
Battery	LiFePO4
Maintained	Non maintained
Operating Hours	30,000
Battery Duration	>3 hours
IP Rating	IP20



Model

**/ALL**

Open area &  
corridor included

**Code Example** R221503/MT/ALL - Vanguard Manual Test 3.5W 6000K Non-Maintained - Open and Corridor optics included.

# Gemini twin spot

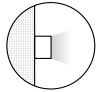

Gemini is a cost effective 3 hour LED emergency twin flood for both interior and exterior applications. It offers high specification optic design, coming supplied with hanging kit for downward pointing installation and integral driver and NiCd battery pack.



Dimensions in mm

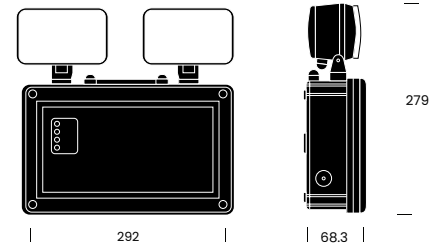

Wattage	2x 3W
Lumens	368
Kelvin	6500K
CRI	>75 Ra
Beam Angle	60°
Battery	Ni-Cd
Maintained	Non maintained
Operating Hours	30,000
Battery Duration	>3 hours
IP Rating	IP65

# Emergency Pack

Emergency Pack is a 3-Hour Emergency kit for RICOMAN downlights and panel lights.

Dimensions in mm

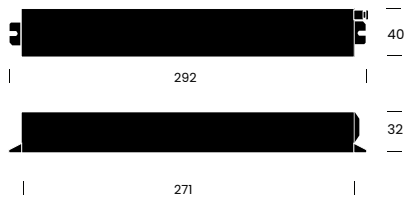

Wattage	3.6W
Lumens	BLF 10%
CRI	>80 Ra
Beam Angle	140°
Operating Hours	>30000
Battery	Ni-Cd
Maintained	Yes
Battery Duration	>3 hours
Recharge Time	24 hours



Options	(SM)	(DC)	(CN)	(SM2)
	Compatible with RICOMAN downlights	Compatible with RICOMAN panel lights	Compatible with RICOMAN tunable downlights	Compatible with RICOMAN Titan Non Corrosive

**Code Example** R10-03E (DC) - Panels' Maintained Universal Emergency Pack 3.6W DC 18-60

R231101

# Blade Exit Sign

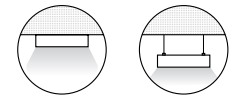

Blade is a 3-hour LED emergency exit sign offering ease of installation along with a sleek aesthetic, accommodating nearly all installation scenarios including surface, recessed, suspended and side mounting. All mounting kits and all legends are included



Dimensions in mm

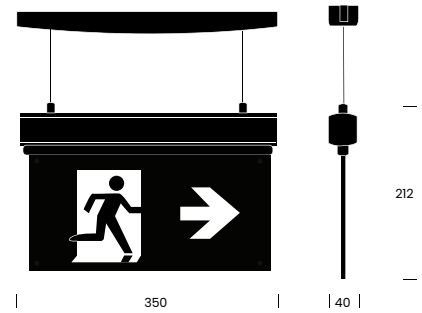

Wattage	2W
Lumens	20
Beam Angle	108°
Battery	Ni-Cd
Maintained	Non maintained
Operating Hours	30,000
Battery Duration	>3 hours

Model

**/ALL**

All Legends included

Code Example R231101/ALL - Blade Multi-Purpose Exit Sign 2W 3 Hrs - All Legends



**Betfred** in Birchwood.  
Blade Exit sign.

# Praevo, self-test emergency

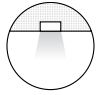

Self-test stand alone 3 hour LED emergency recessed downlight. It is available with open area and corridor optic options included and comes with integrated electronics.



Dimensions in mm

Cut Out: 43

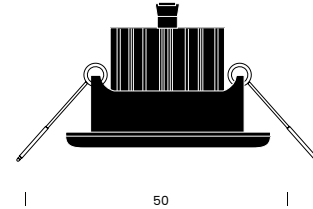

Wattage	3.5W
Lumens	130
Beam Angle	165°(OA) / 160 x 50° (C)
Battery	LI-FE PO4
Maintained	Non maintained
Operating Hours	30,000
Battery Duration	>3 hours

**Model** /ALL  
All Legends included

**Body Colour** /WT White /BK Black

**Code Example** R231101/ALL - Blade Multi-Purpose Exit Sign 2W 3 Hrs - All Legends

R231201

# Salus II IP65 emergency exit bulkhead

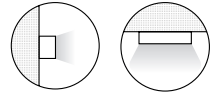

Salus is a maintained or non maintained emergency bulkhead exit sign with IP65 body. The ultra-slim profile LED polycarbonate bulkhead can also be recessed and there is a hinged screw less gear tray for ease of installation.

Dimensions in mm

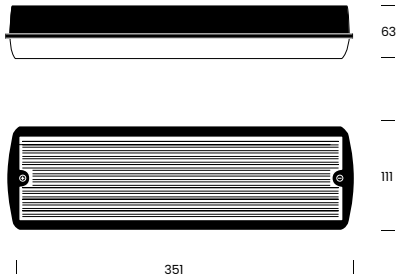

Wattage	3W
Lumens	150 Lm
Kelvin	6500K
CRI	>80 Ra
Beam Angle	120°
Operating Hours	>30000
Self-test	Yes
Manual test	Yes

Options	/ST	/MT	/NL	/E-Z10
	Self test	Manual test	No legends	Z10 Remote control integral emergency

**Code Example** R231202/ST - Salus II Self Test Bulkhead 3W 6500K All legends.

**Accessories**



**R23-01**  
Semi-recessed frame



**R23-02**  
Salus II IP65 ceiling exit sign kit



# Info

# How to navigate a product page.

① **4004201 Pulsar pendant**

Pulsar is a modern pendant combining efficacy with elegance. With a minimalist, contemporary design and durable aluminium construction it can add a touch of subtle stylish architectural lighting in domestic or commercial spaces. The same style luminaire is also available in surface mounted, recessed and track mounted version.



⑤

⑥	Wattage	10W
	Efficiency	80 lm/W
	CR	>90 Ra
	Beam Angle	30° Standard
	Operating hours	50,000
	SOCM	<3
	L70 B50	100,000 hours
	IP Rating	IP20

② **Watts** **75** 5000K **Standard** 4000K

③

④ **Code Example** **4004201/75/30°** - Pulsar pendant 10W, 30° beam angle in 4000K or black. Full part code breakdown on page 55.

①

## Start of product code

Use the reference mention to start creating your product code.

②

## Add info to the product code

Use the custom code references to customise your products.

③

## No added info needed

When standard is showing, no additional code is necessary.

④

## Code Example

At the end of each product page you will find a code example for reference.

⑤

## Mounting icon

Visit the icon page for more detailed information on each icon.

⑥

## Technical information

For any further information not available in the catalogue, please visit our website or datasheets.

# Find all our website features.



## Product Info & Downloads

Find everything you need for our products in one place. Visit our website to access datasheets, LDT files, and product instructions.

## Project Builder

Use the project builder feature to manage your lighting project and send it directly to our team.

## Get Inspired

Visit and download our case studies page and get inspired with our lighting solutions.

**A special thank you**

Thank you for exploring RICOMAN's new catalogue. We extend our heartfelt gratitude to our valued clients for their trust and support, and to all partners involved in our projects. A special thank you to our dedicated team, whose hard work and commitment have made this catalogue possible.

**Art direction**  
RICOMAN Marketing

**Graphic design**  
RICOMAN Marketing

**Illustrations**  
Patricia Duarte

**© RICOMAN Ltd 2024**  
Published by RICOMAN Ltd.

All rights reserved.  
Reproduction in whole or in part of this publication without  
written permission is strictly prohibited. RICOMAN Ltd cannot  
be responsible for unsolicited material. Models and technical  
specifications are subject to modification and enhancements.



**RICCONI<sup>®</sup>**